

RDMRELAY2 MANUAL

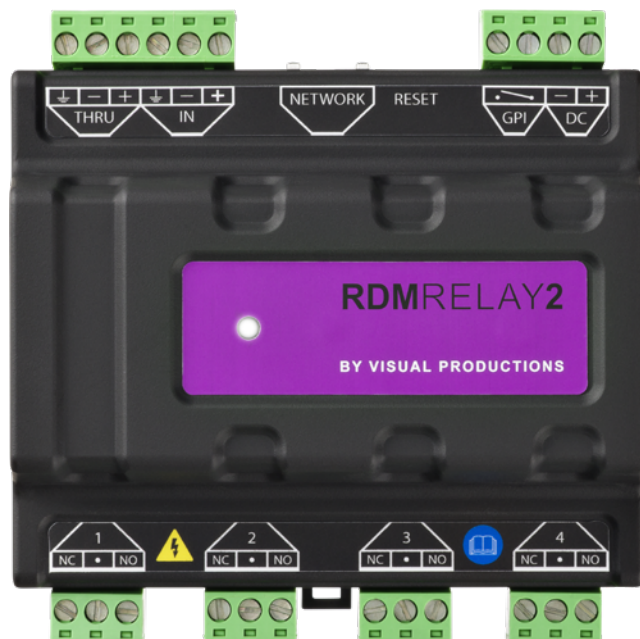

Revision History

Revision	Date	Author(s)	Description
2	15.06.2026	ME	API fix
1	11.06.2026	JL	Initial version

Contents

1	Safety Precautions	5
2	Introduction	7
3	Installation	10
4	Network Configuration	18
5	DMX Control	20
6	GPI Control	25
7	Web-interface	27
8	vManager	33
	Appendices	37
A	API	38
B	Certifications	42

© 2026 Visual Productions BV. All rights reserved.

No parts of this work may be reproduced in any form or by any means - graphic, electronic, or mechanical, including photocopying, recording, taping, or information storage and retrieval systems - without the written permission of the publisher.

While every precaution has been taken in the preparation of this document, the publisher and the author assume no responsibility for errors or omissions, or for damages resulting from the use of information contained in this document or from the use of programs and source code that may accompany it. In no event shall the publisher and the author be liable for any loss of profit or any other commercial damage caused or alleged to have been caused directly or indirectly by this document.

Due to the dynamic nature of product design, the information contained in this document is subject to change without notice. Revisions of this information or new editions may be issued to incorporate such changes.

Products that are referred to in this document may be either trademarks and/or registered trademarks of the respective owners. The publisher and the author make no claim to these trademarks.

Art-Net™ Designed by and Copyright Artistic Licence.

The Visual Productions logo and the term "CueCore" are registered trademarks of Visual Productions BV.

Chapter 1

Safety Precautions

This chapter contains important safety information for the installation, operation, and maintenance of the RdmRelay2. Read these precautions carefully before using the device to ensure safe operation and to prevent damage to equipment or injury to personnel.

Before installing the RdmRelay2, read this manual completely and ensure that all installation personnel are familiar with the product and applicable safety requirements. Verify that the installation environment is suitable for the device and within the specified operating conditions. Disconnect power before making any wiring connections. Do not install or operate the product if it appears damaged. Ensure adequate ventilation around the unit and prevent exposure to moisture, excessive heat, or mechanical stress.

1.1 Indoor Use Only

The RdmRelay2 is intended for indoor use only. Do not install or operate the device in environments exposed to rain, moisture, condensation, excessive dust, or direct sunlight. Operating the product outside its specified environmental conditions may result in malfunction, damage, or reduced product lifetime.

1.2 Power Supply Requirements

Only power the RdmRelay2 using the approved power sources specified in this manual: a DC power supply within the specified input voltage range. Applying voltages outside the specified limits may damage the device and void the warranty.

1.3 High Voltage



The RdmRelay2 can switch mains voltages up to 250 VAC. Incorrect installation, wiring, or operation may result in equipment damage, electric shock, serious injury, or death. Installation must be carried out by qualified personnel and in accordance with local electrical regulations.

1.4 No User-Serviceable Parts



The RdmRelay2 contains no user-serviceable parts. Do not attempt to open, disassemble, or repair the device. Opening the enclosure may expose sensitive electronic components and may void the warranty. Repairs must only be carried out by qualified service personnel or the manufacturer.

1.5 Product Modifications



Do not modify the RdmRelay2 or its accessories. Unauthorized modifications may impair product performance, compromise safety, invalidate regulatory compliance certifications, and void the warranty.

1.6 Disconnect Power Before Servicing



Always disconnect all power sources and any external DC supply, before installing, wiring, relocating, or servicing the device. Failure to disconnect power may result in equipment damage or unintended operation.

Chapter 2

Introduction

Thank you for choosing the **RdmRelay2** by Visual Productions.

The RdmRelay2 provides a simple and reliable solution for remotely switching AC- or DC-powered loads. It features four independent relays, each offering both normally open (NO) and normally closed (NC) contacts.



Figure 2.1: RdmRelay2

The relays can be controlled directly via DMX, Art-Net, sACN, GPI, or through network-based API messages, including OSC, UDP, and TCP. This flexibility makes the RdmRelay2 suitable for a wide range of applications, from lighting control and show automation to general-purpose integration projects.

2.1 Compliance

This device is in compliance with the following regulations:

- CE
- UKCA

See the appendix for the associated certificates.

2.2 Features

The feature set of the RdmRelay2 includes:

- Four AC/DC relays
- AC/DC type detection and current sensor
- DMX-512 (ANSI E1.11) optically isolated input
- RDM (ANSI E1.20)
- 10/100 Mbit/s Ethernet port
- Web-based user interface
- Art-Net V4 input
- sACN E1.31 input
- GPI contact-closure port
- DIN-Rail form-factor
- Power consumption 9-24V DC 500mA
- Operating temperature -20°C to +50°C (-4°F to 122°F)
- Operating relative humidity 10% to 80% non-condensing

2.3 What's in the box?

The RdmRelay2 packaging contains the following items (see figure 2.2):

- RdmRelay2 with four-pin and six-pin terminals installed
- 4 three-pin terminal blocks
- 1m network cable
- Quick Start card



Figure 2.2: RdmRelay2 box contents

2.4 Unpacking

Carefully unpack the RdmRelay2 and inspect the contents for any signs of damage that may have occurred during transportation. Verify that all supplied accessories and documentation are present. If any damage is found, do not install or operate the device and contact your supplier immediately. Retain the original packaging materials whenever possible, as they provide the safest means for transporting or storing the product in the future.

2.5 Intended Disposal

At the end of its service life, this product must not be disposed of with household waste. The RdmRelay2 contains electronic components that should be collected and recycled in accordance with local regulations for Waste Electrical and Electronic Equipment (WEEE). Please dispose of the product through an authorized recycling facility or return it to an appropriate electronic waste collection point. Proper disposal helps conserve natural resources and prevents potential negative effects on the environment.

2.6 Further help

If, after reading this manual, you have further questions, then please consult the online forum at <https://forum.visualproductions.nl>

Chapter 3

Installation

Installing your RdmRelay2 is straightforward. However, it is important to observe the relevant safety precautions. Be sure to read Section 3.5 before connecting or operating the relay outputs.



Warning: Exercise caution when working on the device connections. Ensure that all power sources are disconnected before making or modifying any connections.

3.1 DIN Rail

The RdmRelay2 is designed for mounting on a standard DIN rail and occupies 6 DIN modules of width.

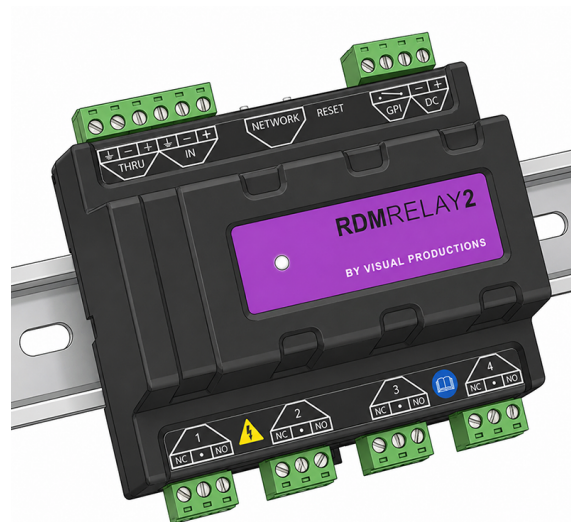

Figure 3.1: DIN rail mounting

3.2 DC Power

The RdmRelay2 can be powered from a DC supply with an input voltage between 9V and 24V DC. The power input is protected against reverse polarity. A suitable power supply is required and is sold separately.

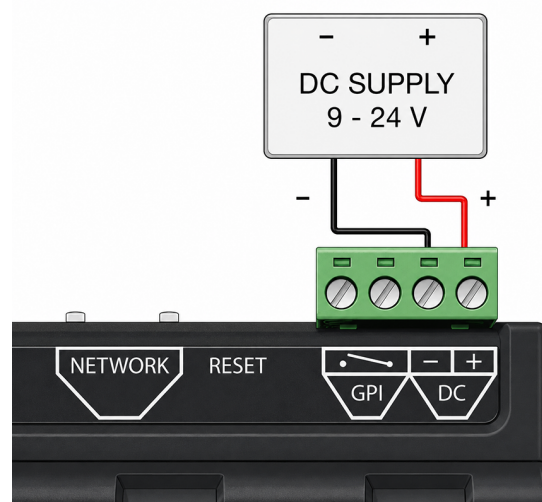

Figure 3.2: DC power connection

3.3 Status LED

The status LED indicates the current state of RdmRelay2. The LED color varies depending on the device state.

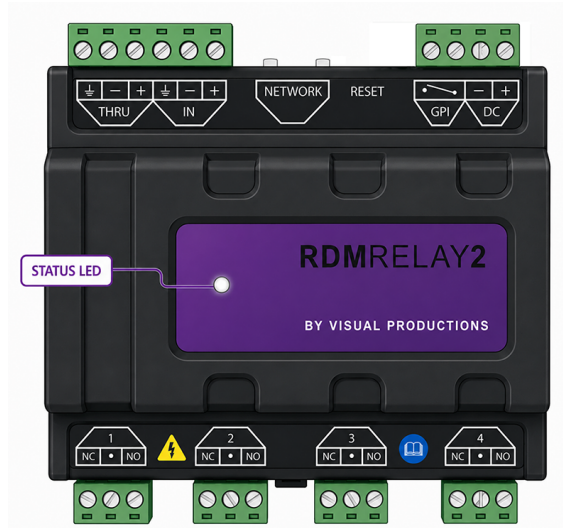







Figure 3.3: Status LED

LED Status guide:

-  **Red** Normal operation, DHCP mode
-  **White** Normal operation, Static IP mode
-  **Purple** Factory Default reset in progress
-  **Cyan** Firmware upgrade in progress
-  **Orange** Error, consult tech support

3.4 DMX

The RdmRelay2 is controlled by DMX-512. The DMX port on the RdmRelay2 has a six-pin terminal block. Connect the DMX network to the IN terminals. The THRU terminals continue the DMX signal to the next device.

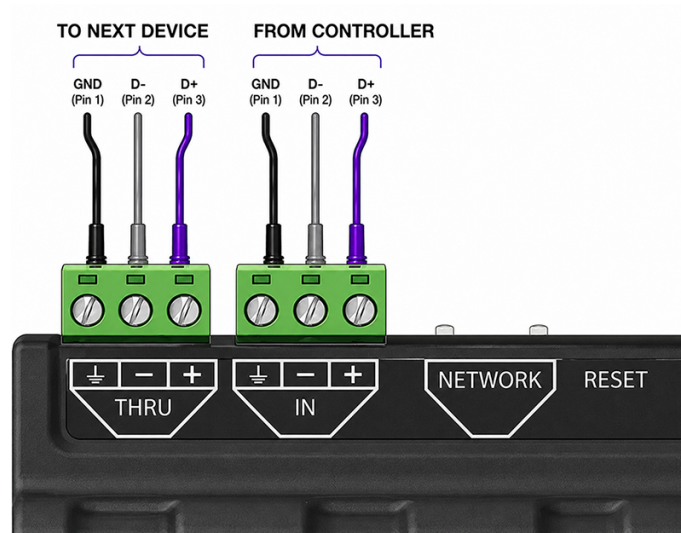

Figure 3.4: DMX connection

3.5 Relays

The RdmRelay2 features four relays capable of switching mains powered equipment. Due to the hazard of working with high power electricity; the instructions in this chapter need to be carefully considered.

3.5.1 Wiring

Use wire gauges that are compliant with the power requirements of the load that is to be connected. We advise to use solid core wiring.



Important: A fuse should always be supplied in the line from the power supply to the relay. See figure 3.5.

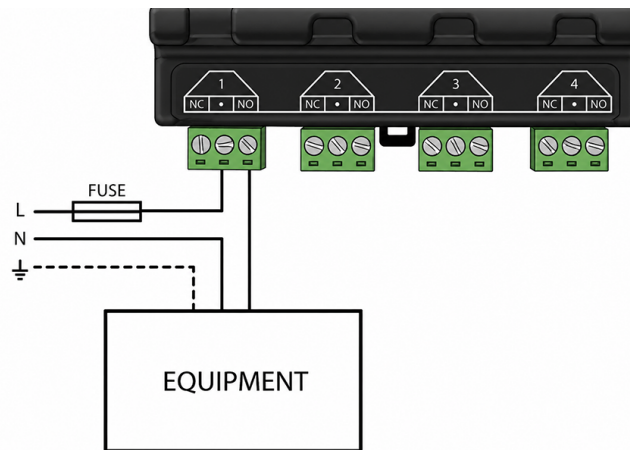

Figure 3.5: Relay wiring

3.5.2 Normally Open vs. Normally Closed

Each relay output provides three terminals: NC (Normally Closed), common, and NO (Normally Open).

The terms Normally Open and Normally Closed describe the state of the relay when it is not activated.

- Normally Open (NO): The circuit is disconnected when the relay is off. When the relay is activated, the common and NO terminals are connected, allowing current to flow.
- Normally Closed (NC): The circuit is connected when the relay is off. When the relay is activated, the connection between common and NC is opened, interrupting the current flow.

Use the NO terminal when equipment should remain off until the relay is activated. Use the NC terminal when equipment should remain on and be switched off when the relay is activated.

Example: A warning light that should turn on only when triggered would typically be connected using NO. An emergency stop circuit that must remain connected during normal operation may use NC, so that the circuit opens when the relay is activated or loses power.

3.5.3 Resistive vs. Inductive

Relay contacts can switch different types of electrical loads. The two most common categories are resistive loads and inductive loads.

- Resistive loads draw a steady current and do not store significant energy. Examples include incandescent lamps, electric heaters, and resistive heating elements. These loads are generally easy for relay contacts to switch.
- Inductive loads store energy in a magnetic field and can generate high voltage spikes when switched off. Examples include motors, neon drivers and transformers. These loads place greater stress on relay contacts and can reduce their lifetime if not properly protected.



Important: Relay contact ratings for inductive loads are typically lower than for resistive loads. Always verify that the connected load is within the specified relay ratings.

When your project requires switching heavy inductive loads then it is recommended to put a AC-7b type relay in between the RdmRelay2 and the load.

3.5.4 Maximum Loads

The RdmRelay2's relays are capable of handling the following power configurations:

Load Type	Maximum Amperage
30V DC Resistive	12A
250V AC Resistive	12A
30V DC Inductive	6A
250V AC Inductive	6A



Warning: Do not exceed these maximum ratings; doing so has the risk of fire and/or equipment damage.

3.5.5 Relay Lifetime

Switching of different loads, voltages and types of current have a different impact on the life of the relay. Simply put, the lower the voltage and current used, the more switching cycles the relay is able to have before wearing out and needing to be replaced. Higher voltages and amperages can increase the wear significantly, lowering the life expectancy of the relay. With the data in the figure 3.6, you can estimate the lifetime of the relays in your particular setup.

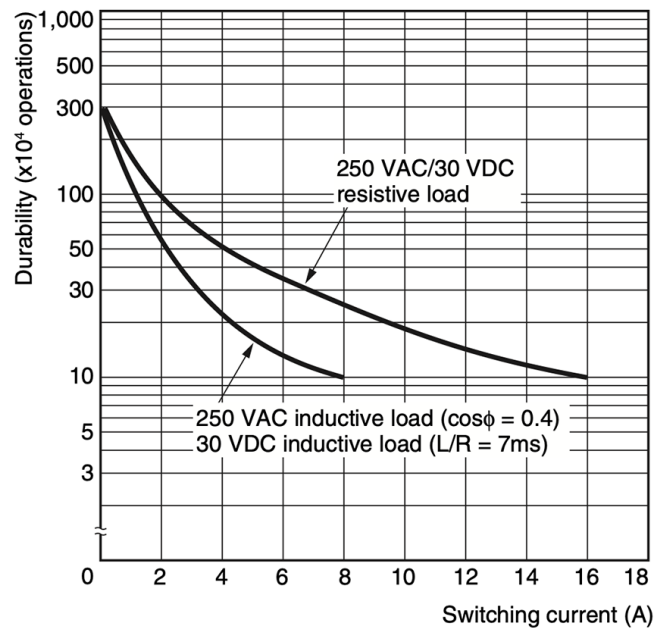

Figure 3.6: Relay lifetime [Source: Omron]

3.5.6 Current Sensors

Each relay is equipped with an integrated Hall-effect current sensor. The sensor monitors the current flowing through the relay's common (COM) terminal, allowing current measurements regardless of whether the load is connected to the normally open (NO) or normally closed (NC) contact.

- Maximum measurable current: 16A
- Resolution: 0.1A



Important: The current sensors are intended for monitoring purposes only. They are not calibrated measurement instruments and must not be used where accurate current measurements are required.

3.6 GPI

The RdmRelay2 features a GPI port that allows control of the relays via a contact-closure. Refer to chapter 6 on page 25 for details.

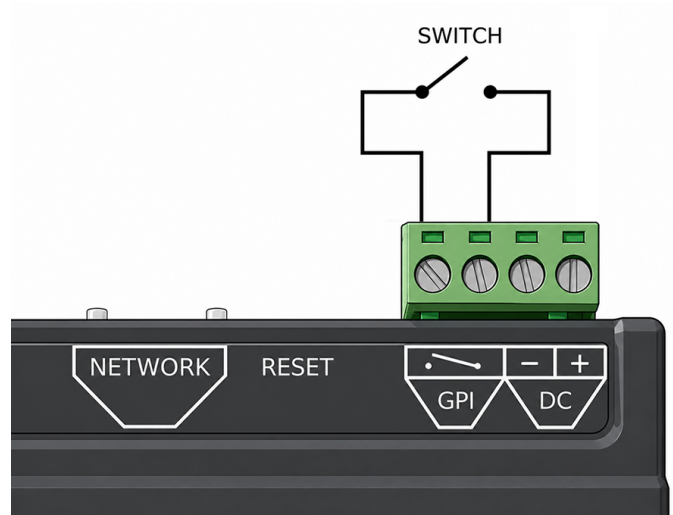

Figure 3.7: GPI port

Chapter 4

Network Configuration

This chapter explains the network configuration options available on the RdmRelay2. It describes IP addressing, DHCP operation, and the methods available for configuring or restoring network settings.

4.1 IP Address

The RdmRelay2 supports both static IP addresses and automatic IP addresses. By default, the RdmRelay2 is set to 'DHCP' in which it will be automatically assigned an IP address by the DHCP server in the network.

If the RdmRelay2 is set in DHCP mode and no DHCP server is present in the Network, it will automatically fall back to a random IP address in the range 169.254.xx.xx after a few seconds.

Static IP addresses are useful, for instance when there is a direct peer-to-peer connection between a RdmRelay2 and a computer. It is also useful in permanent installations where the IP address of the RdmRelay2 is known by other equipment and therefore should not change. When using DHCP there is often the risk of automatically being given a new IP address in the event that the IP lease time runs out. When using static IP addresses make sure that all equipment on the network has a unique IP addresses within the same subnet.

The RdmRelay2's LED helps to determine which kind of IP address is set. The LED will indicate red when using DHCP and it will indicate white in the case of a static IP address.

There are three ways to change the IP address setting of the RdmRelay2.

- **vManager** can be used to detect a RdmRelay2 on the network. Once found, the vManager software (figure chapter 8) allows for changing the IP address, subnet mask and DHCP settings.
- If the IP address is already known then browsing to this address using the computer's browser will show the RdmRelay2's **web-interface**. The Settings page on this web-interface enable changing the same network related settings.
- Briefly using the **reset button**. As described in the next section.

4.2 Reset Button

The *Reset Button* is located on the side of the device.

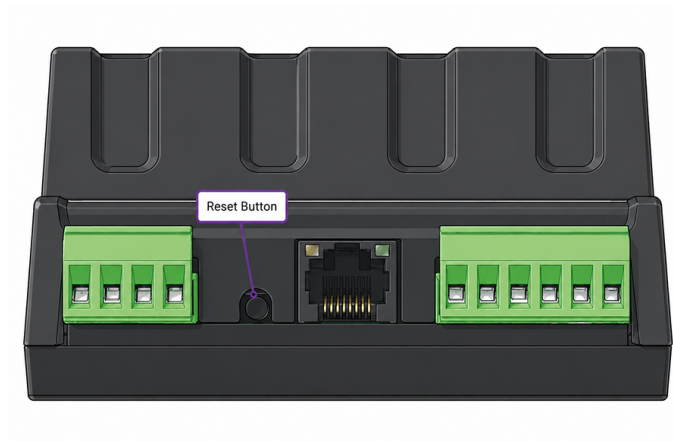

Figure 4.1: Reset button

The reset button provides several functions depending on how it is used:

Short press Toggles the IP address mode between *DHCP* and *Static IP*.

Long press Press and hold the button until the status LED starts flashing white. The RdmRelay2 will revert its IP settings to the default static IP address of 192.168.1.10.

Power-on reset Press and hold the reset button while applying power to the RdmRelay2. Release the button when the purple status LED stops flashing. The device will be restored to its factory default settings. All user settings, configuration data, and IP settings will be erased.

Chapter 5

DMX Control

When *DMX* is selected as the control source (see page 31), the relays are controlled directly from a DMX-512 signal. DMX control also enables RDM (Remote Device Management) support, allowing compatible controllers to discover and configure the device remotely.

5.0.1 Start Address

The factory default starting address of the RdmRelay2 is at DMX channel 001.

The DMX start address can be configured from the Settings Page or through an RDM-compatible controller.

5.1 DMX Modes

Three DMX operating modes are available. The desired mode can be selected either via the web interface or through RDM.

Hysteresis

The DMX modes make use of *hysteresis*. Hysteresis improves switching stability by preventing a relay from repeatedly changing state when the DMX value fluctuates near the switching threshold.

Without hysteresis, small variations in the DMX signal could cause repeated switching when the value is close to the trigger point. This behavior may lead to unnecessary relay wear and unintended operation of connected equipment.

When hysteresis is enabled, separate thresholds are used for switching on and switching off. For example, a relay may switch on when the DMX value rises above 128, but only switch off when the value falls below 120. Values between these thresholds do not cause a change in relay state.

The resulting dead band around the switching point ensures stable operation, even when the DMX signal contains small fluctuations.

5.1.1 Standard Mode

In *Standard* mode, each relay is controlled by a dedicated DMX channel.

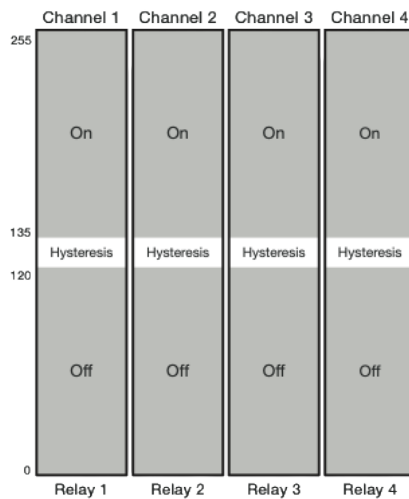

Figure 5.1: Standard mode

5.1.2 Arm Mode

Arm mode adds an additional safety channel that must be enabled before the relays can be operated.

The arm channel must be set to 250 or higher before any relay can be closed.

If the arm channel falls below 250, all relays are immediately opened.

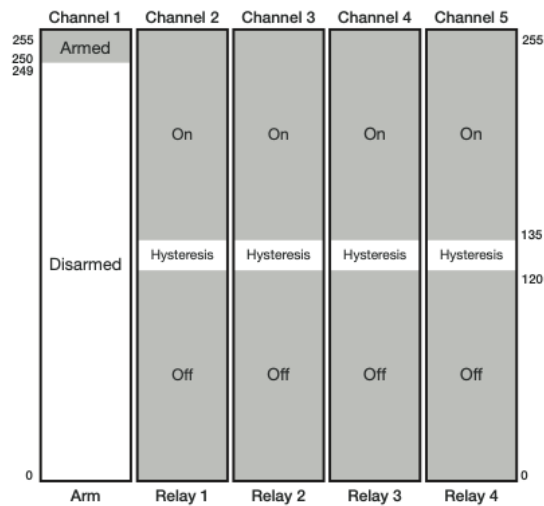

Figure 5.2: Arm mode

To prevent unintended activation when the arm channel is enabled, relay channels that are already above the switching threshold are ignored until they first return to the *Off* range.

5.1.3 Protect Mode

Protect mode also uses an enable channel.

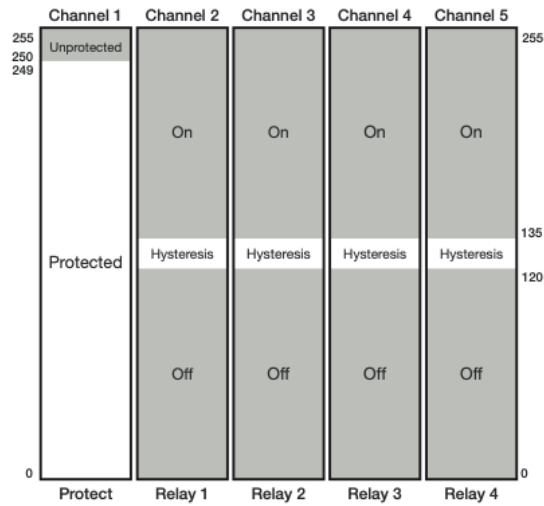

Figure 5.3: Protect mode

The protect channel must be set to 250 or higher before relay channels can change state.

Unlike *Arm* mode, lowering the protect channel does not affect the current relay states. All relays remain in their existing state until commanded otherwise.

5.1.4 RDM

Use a RDM capable device to change the starting address or DMX mode. As an example, figure 5.4 illustrates how set the address by using a Visual Productions' CueCore3.

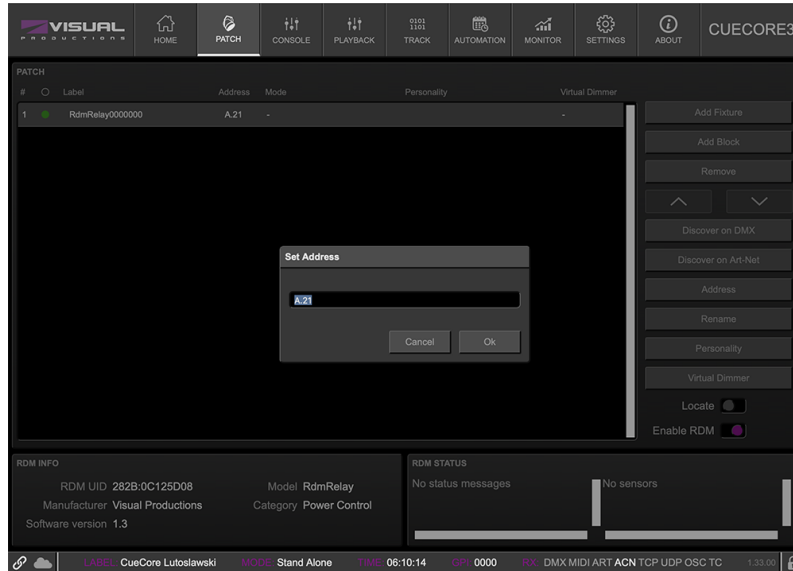

Figure 5.4: Changing the starting address via RDM

The following RDM parameters are supported by the RdmRelay2:

Hex	Parameter
0x0050	Supported Parameters
0x0060	Device Info
0x0080	Device Model Description
0x0081	Manufacturer Label
0x0082	Device Label
0x00C0	Software Version Label
0x00E0	DMX Personality
0x00E1	DMX Personality Description
0x00F0	DMX Start Address
0x0200	Sensor Definition
0x0201	Sensor Value
0x1000	Identify Device

The following RDM status messages are accessible:

Hex	Status
0x05	Ampere DC (0 when AC type is detected)
0x07	Ampere AC RMS (0 when DC type is detected)

Chapter 6

GPI Control

The relay outputs can also be controlled via the GPI (General Purpose Input) port. To enable GPI control, select *GPI* as the control source in the device settings (see page 31).

6.1 Switch Type

Connect a push-button or switch to the GPI contact-closure input.

When using a **momentary switch** (for example, a push-button), select *Pulse* mode. Each activation of the input will trigger the configured relay action.

When using a **maintained switch** (for example, a rocker or toggle switch), select *Switch* mode. In this mode, the relay outputs follow the state of the external switch.

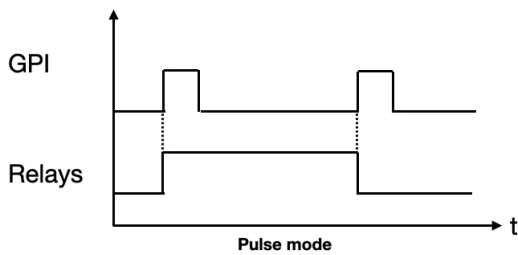

Figure 6.1: Pulse mode

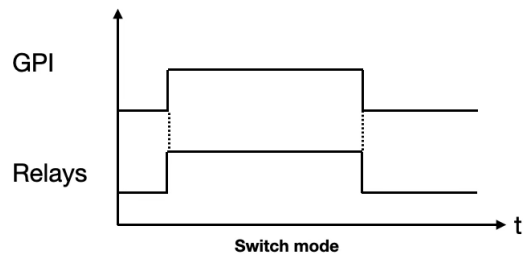

Figure 6.2: Switch mode

6.2 Cascade

By default, all relay outputs switch simultaneously when triggered by the GPI.

When *Cascade* mode is enabled, the relay outputs switch sequentially, with a one-second delay between each output.

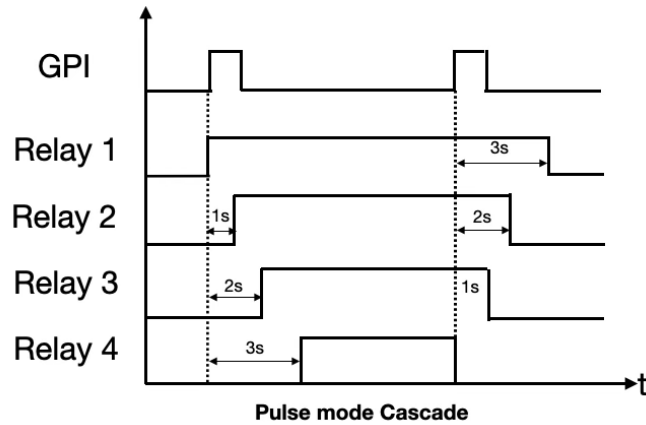

Figure 6.3: Pulse-Cascade mode

Cascade mode is particularly useful when controlling equipment with high inrush currents, such as power amplifiers or large power supplies, as it reduces the peak current drawn at switch-on.

Chapter 7

Web-interface

7.1 Home Page

The *Home* page provides a real-time overview of the RdmRelay2 and the loads connected to it. In addition to basic device information, it gives immediate insight into relay status, measured load currents, detected load types, switching activity, and active control sources.

For many installations, the *Home* page serves as the primary diagnostic tool. It allows installers and operators to quickly verify correct operation, identify overloaded circuits, and monitor relay usage without requiring external measurement equipment.

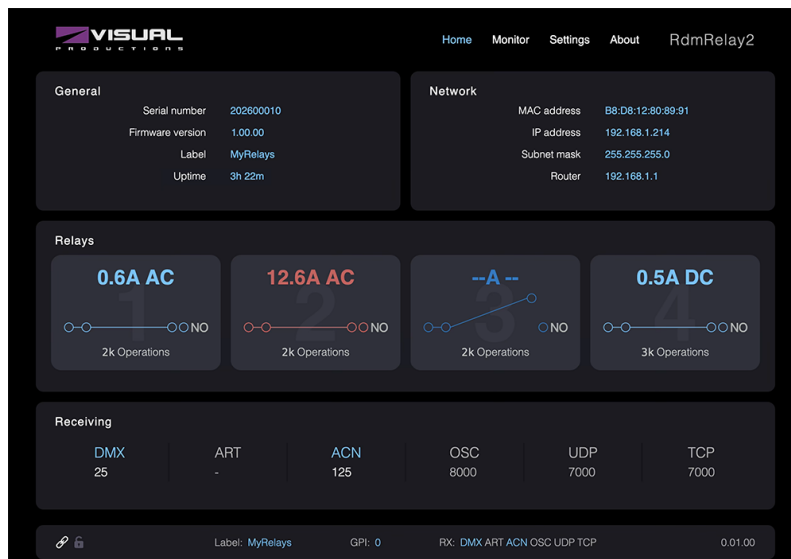

Figure 7.1: Home Page

When password protection is enabled, the *Home* page and *About* page remain accessible without authentication, allowing operational status to be checked while preventing unauthorized configuration changes.

7.1.1 General

The *General* section displays device information, including the serial number, firmware version, user-defined label, and uptime. The uptime indicates how long the device has been running since its last reboot.

7.1.2 Network

The *Network* section displays the current network configuration, including the MAC address, IP address, subnet mask, and default gateway. Network settings can be modified from the Settings Page or by using *vManager*.

7.1.3 Relays

The *Relays* section provides detailed status information for each relay output.

For every relay, the following information is displayed:

- Current relay state (NO or NC)
- Detected load type (AC or DC)
- Measured load current
- Total number of relay switching operations

The measured current allows connected loads to be verified without external test equipment. This can help identify disconnected equipment, unexpected load conditions, or circuits that are drawing more current than anticipated.

The switching operation counter records how many times each relay has changed state during its lifetime. This information can be used to assess relay wear, support preventative maintenance, and assist in troubleshooting installations that perform frequent switching.

If the measured current exceeds the relay's rated specification, the current value is highlighted in red. Continued operation above the specified ratings may reduce relay lifetime and can result in damage to the relay contacts.

For more information about relay ratings and switching endurance, refer to the *Maximum Loads* and *Relay Lifetime* sections on page 15

7.1.4 Receiving

The *Receiving* section indicates which control protocols are currently active. Active protocols are highlighted.

Additional information is displayed depending on the protocol:

- **DMX** Start address
- **Art-Net** Subnet and universe
- **sACN** Universe number
- **OSC, UDP, TCP** Listening port number

For Art-Net and sACN, hovering the mouse pointer over the protocol indicator displays the IP address of the currently active source.

7.2 Monitor Page

The *Monitor* page provides real-time monitoring of DMX, Art-Net, sACN, OSC, UDP, and TCP traffic received or transmitted by the RdmRelay2.

Use the sidebar to select the protocol you wish to monitor.

For DMX, Art-Net, and sACN, the *Monitor* page displays the value of each individual channel. Changes in channel values are highlighted using a dynamic color indication system, making activity easy to identify.

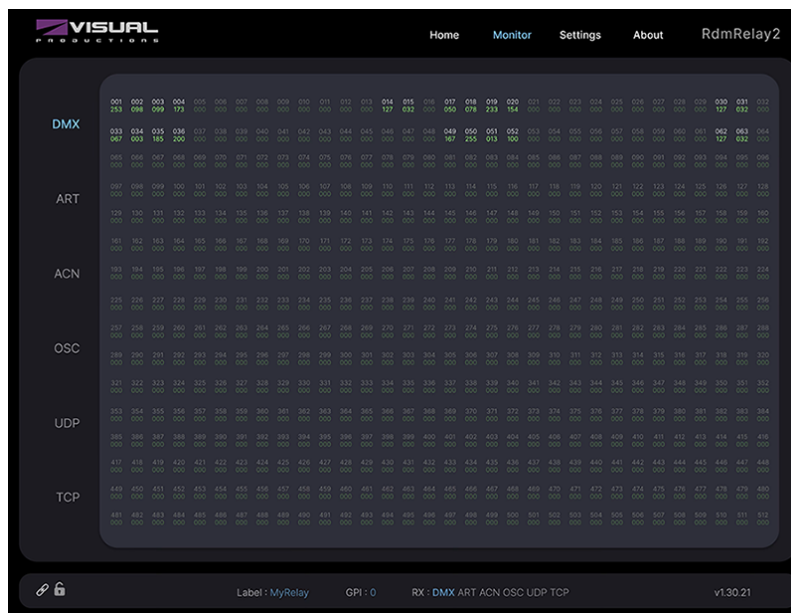

Figure 7.2: Monitor page

For OSC, UDP, and TCP, both transmitted and received messages are displayed. Each message entry includes the source or destination IP address and port number, along with a timestamp indicating the device uptime at the moment the message was processed.

Messages that conform to the RdmRelay2 API are highlighted in blue, while messages that do not match the API format are displayed in white.

7.3 Settings Page

The *Settings* page provides access to the configuration options of the RdmRelay2. From this page you can configure device identification, network settings, control input parameters, and API communication settings.

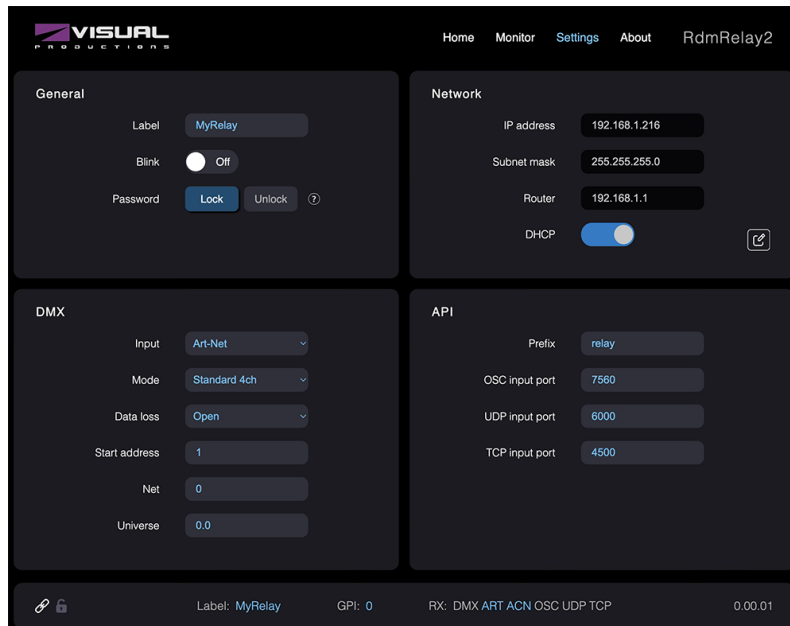

Figure 7.3: Settings page

7.3.1 General

The *General* section contains device-specific settings.

Label The label is a user-defined name used to identify the device. It is displayed on the *Home* page, in the web browser title bar, and in *vManager*. The maximum label length is 32 characters.

Blink Activating *Blink* causes the status LED to flash, making it easier to identify a specific device when multiple units are installed.

Password Protection Password protection prevents unauthorized modification of device settings. When enabled, all pages remain accessible, but configuration changes are disabled until the correct password is entered.

If the password is lost, password protection can be removed by pressing and holding the *Reset* button until the status LED starts blinking white. This procedure also restores the factory default network settings. Refer to the *Reset Button* section on page 19 for details.

7.3.2 Network

The *Network* section contains the Ethernet configuration of the device, including the IP address, subnet mask, and default gateway.

The device can operate in either *Static IP* mode or *DHCP* mode.

When DHCP is enabled, the device requests its network settings from a DHCP server. As a result, the IP address may change and the currently displayed web page may become unreachable.

When switching from DHCP mode to Static IP mode, the desired network settings must be entered manually.

If DHCP is enabled but no DHCP server is available, the device automatically assigns itself a link-local address in the range 169.254.x.x after a timeout period.

7.3.3 DMX

The *DMX* section is used to configure the relay control source and protocol-specific settings.

The following control sources are available:

- DMX
- Art-Net
- sACN
- GPI
- API

Depending on the selected control source, additional configuration parameters become available.

Data Loss Behavior The *Data Loss* setting determines how the device responds when the DMX signal is lost.

The following options are available:

Hold All relays remain in their current state.

Open All relays are opened.

Close All relays are closed.

The selected data loss state remains active until one of the following occurs:

- A valid DMX signal is received again.
- A different control source is selected.
- The device is restarted.

7.3.4 API

The *API* section contains the network settings used for OSC, UDP, and TCP communication.

Prefix Defines the API command prefix used in OSC messages.

Input Ports The listening port for each protocol can be configured individually.

Default ports are:

- OSC: 8000
- UDP: 7000
- TCP: 7000

The RdmRelay2 will record the 4 last IP addresses of the devices which sent it API messages (4 IPs per protocol) and will automatically send the EVENT commands to the stored IP.

When API is not selected as input, only the SET commands are deactivated. The RdmRelay2 will continue answering Get commands and send EVENT messages.

Find the list of the available API messages in the appendix on page 38.

7.4 About Page

The *About* page provides information about the RdmRelay2, including firmware and hardware details, Visual Productions support resources, development credits, and legal notices.

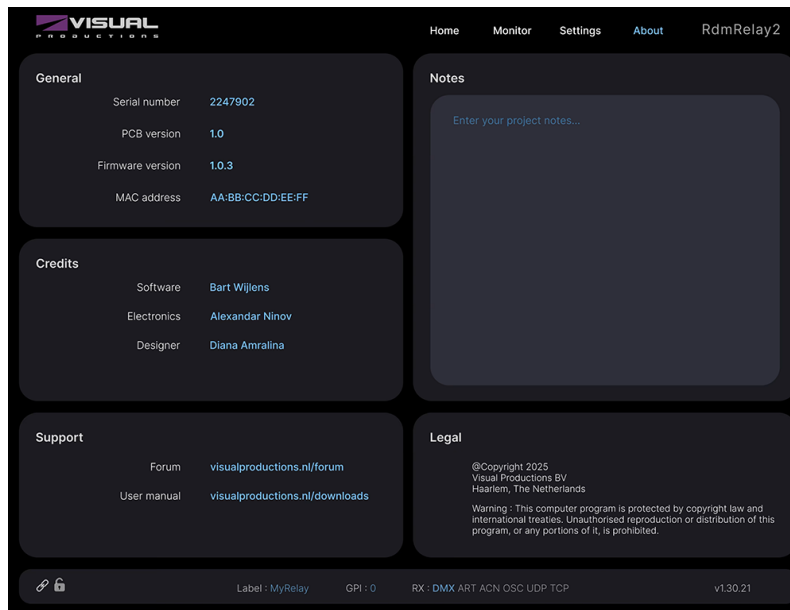

Figure 7.4: About page

The page also includes a *Notes* field, allowing you to store project-specific information, installation details, or other relevant remarks. Notes are stored locally on the device and can contain up to 256 characters.

Chapter 8

vManager

A free-of-charge software tool called vManager has been developed to manage the devices. vManager allows you to:

- Label your device with a distinguishable name
- Configure the IP address, subnet mask, router and DHCP
- Backup and restore the device's data and settings
- Perform firmware upgrades
- Identify a specific device (in a multi device set-up) by blinking its LED
- Revert to factory defaults

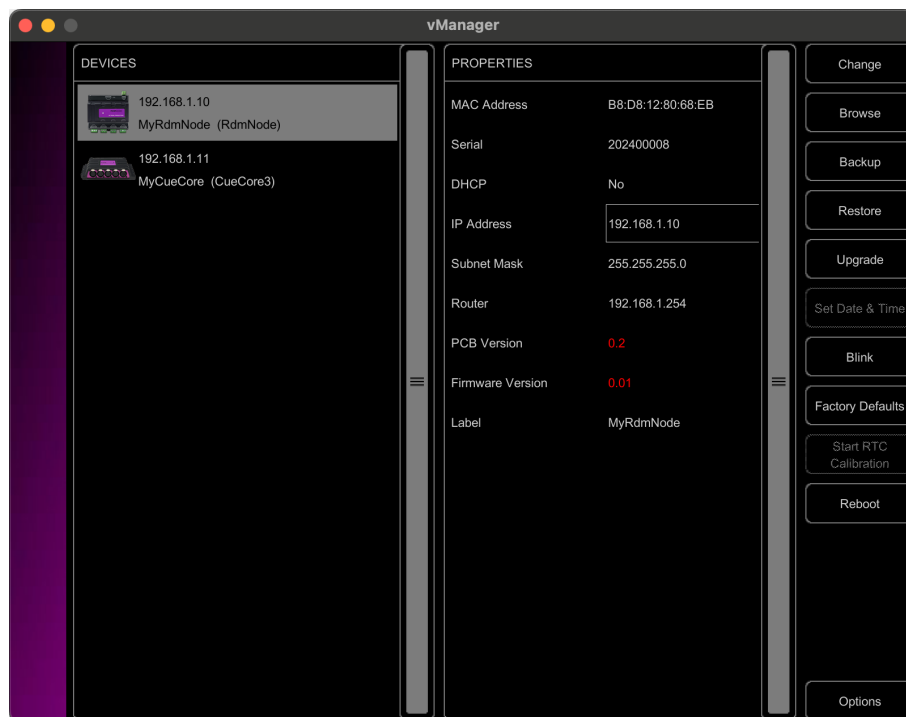

Figure 8.1: vManager

The following section explains the buttons in the vManager, as seen in figure 8.1.

8.1 Backup

Backups of all the programming data inside the RdmRelay2 can be made. This backup file is saved on the computer's hard-disk and can be easily transferred via e-mail or USB stick. The data of the backup can be restored via the *Restore* button. You have the option to choose subsections of a backup, such as just ShowControl, or Settings and Tracks, for example. Use the checkboxes on the right to make your choice.

All options are enabled, so a full backup is made, by default.

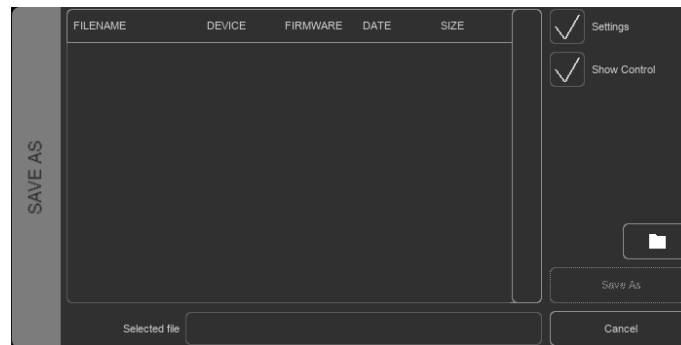

Figure 8.2: Creating a backup for the RdmRelay2

Apps distributed by app stores are not always allowed to access files outside their designated location. It is important to know where vManager is storing its files, in case you wish to transfer a backup file to a memory stick or dropbox.

This file location differs per operating system and can be a long and obscure path. For this reason, vManager provides you with a shortcut to the correct file location. A *Folder* button can be found in the file related dialogs. Clicking this button will open a file browser at the appropriate folder.

8.2 Upgrade Firmware

vManager will show the firmware version of a selected device in orange when a newer *Release* version is available. To upgrade the firmware, make sure the device is selected and press the *Upgrade* button. The dialogue allows for selecting from the list of available firmware versions. Firmware versions in the list will show whether they are stable 'release' versions or 'beta' with new and or experimental functionality. We, at Visual Productions, advise to not use beta versions in production environments.



FIRMWARE	VERSION	DATE	SIZE
CueCore1	1.89	2015-10-13	423kB
CueCore1	1.46	2013-02-25	421kB
IoCore	1.39	2017-04-13	351kB
IoCore	1.38	2015-12-17	343kB
B-Station	1.27	2017-04-11	493kB
B-Station	1.25	2015-12-17	489kB

Figure 8.3: Firmware upgrade



Important: Make sure the power to the device is not interrupted during the upgrade process.

8.3 Blink

The device's status LED can be set to *Blink* fast for about 2 seconds, to identify the specific unit amongst multiple devices. This blinking is enabled by double-clicking on a device in the Devices list or by selecting a device and then clicking the Blink button. Alternatively, browse to the Settings page of the device, and choose Blink in the top left. Now the device will blink as long as the slider is set to 'on'.

8.4 Factory Defaults

All the user data, like cues, tracks and actions are stored in the on-board memory. They will be completely erased and all settings reverted to their defaults by pressing the *Factory Defaults* button. This action does not affect the device's IP settings.

8.5 Reboot

The *Reboot* button allows you to remotely restart the device. This is useful for testing the unit's behaviour after a power-cycle.

8.6 Installing vManager

The vManager app is available on the most common range of operating systems.

The software is distributed through app-stores to make receiving future updates automatic and very easy.

Note: vManager is no longer provided for mobile devices such as tablets or mobile phones.

8.6.1 Windows

Visit the Microsoft store at <https://www.microsoft.com/en-us/p/vmanager/9nblggh4s758>.

Windows 11 is required.

8.6.2 macOS

Visit the Apple macOS app store at <https://apps.apple.com/us/app/vmanager/id1074004019>.

macOS 26.5 is recommended.

8.6.3 Ubuntu

You can acquire the vManager from Snapcraft at <https://snapcraft.io/vmanager>.

Alternatively, it can be installed by using the command-line:

```
snap find vmanager
snap install vmanager
```

To update the apps later on via the command-line type:

```
snap refresh vmanager
```

Ubuntu 26.04 LTS is recommended. The software is only available for the amd64 architecture.

Appendices

Appendix A

API

This appendix describes the API commands available for RdmRelay2 devices.

The commands are organized into logical categories. Each section provides a brief description followed by a reference table containing the command URI, data type, and value information.

Most commands are available in both **get** and **set** variants:

* **Get** commands retrieve the current value or configuration from the device. * **Set** commands update a configuration value on the device.

Some commands are read-only and therefore only support the get variant. This is indicated in the corresponding reference tables.

API commands use the following format:

GET API Prefix/get/URI Definition

SET API Prefix/set/URI Definition=value

The API prefix is configurable and can be viewed or modified on the *Settings* page.

For OSC communication, all commands must be preceded by a leading forward slash (/). For UDP and TCP communication, forward slashes (/) are replaced by hyphens (-).

The RdmRelay2 automatically keeps track of the last four IP addresses from which valid API messages were received. Device status changes, updates, and notifications are automatically transmitted to these addresses.

A.1 OSC

A.1.1 Hello commands

Command	Argument	Description
/[prefix]/hello	-	Returns the string <i>hello-back</i>

A.1.2 Device commands

	Command	Argument	Description
Get	<code>/{{prefix}}/get/device/name</code>	Boolean	Returns the product name of the device <i>RdmRelay2</i> .
Get	<code>/{{prefix}}/get/device/uptime</code>	Boolean	Returns the up time of the device in: "hh mm", "dd hh" or "yy dd". (e.g. 1h 45m, 250d 23h or 1y 360d).
Get	<code>/{{prefix}}/get/settings/label</code>	String	Returns the label of the device. (e.g. <i>MyRelay</i>).
Set	<code>/{{prefix}}/set/device/blink</code>	-	The device will blink for 5 seconds.
Set	<code>/{{prefix}}/set/device/blink</code>	Boolean	The device will permanently blink.

Example: `/relay/set/device/blink Argument=on =>Activate the blink setting`

A.1.3 Relay commands

The `{id}` field denotes the relay port (1 - 4). For the position of the relays, the boolean value (`false`) relates to open and `true` to closed.

	Command	Argument	Description
Get	<code>/{{prefix}}/get/r{id}/position</code>	Boolean	Returns a boolean with the position of the relay.
Get	<code>/{{prefix}}/get/r{id}/current</code>	Integer	Returns an integer with the measured current for the relay.
Set	<code>/{{prefix}}/set/r{id}/position</code>	Boolean	Sets the relay to the defined position.
Set	<code>/{{prefix}}/set/r{id}/toggle</code>	-	Toggle a relay.
Set	<code>/{{prefix}}/set/all/toggle</code>	-	Toggle all relays.
Set	<code>/{{prefix}}/set/all/position</code>	Boolean	Sets all the relays to one position. This command respects the configured mode, meaning that if cascade is configured, the relays will all switch in cascade.

Example: `/relay/set/r3/position Argument=on =>Set Relay 3 to closed`

A.1.4 Event commands

Command	Argument	Description
/[prefix]/rid/onchange	Boolean	Indicates the status of a relay when it changes.
/[prefix]/gpi/onchange	Boolean	Indicates the status of a GPI when it changes.

A.2 UDP and TCP

For TCP communication, the RdmRelay2 determines the end of a message by detecting a carriage return and line feed sequence (`\r\n`).

Depending on the operating system, programming language, or software used, these characters may be represented or encoded differently.

Some TCP clients automatically append the required end-of-line characters to transmitted messages, while others require them to be included explicitly. Refer to the documentation of your TCP client or control system to determine how to append the `\r\n` sequence to outgoing messages.

UDP messages do not require message termination characters, as each UDP packet is received as a complete message.

A.2.1 Hello commands

Command	Argument	Description
{prefix}-hello	-	Returns the string <i>hello-back</i>

A.2.2 Device commands

	Command	Argument	Description
Get	{prefix}-get-device-name	Boolean	Returns the product name of the device <i>RdmRelay2</i> .
Get	{prefix}-get-device-uptime	Boolean	Returns the up-time of the device in: "hh mm", "dd hh" or "yy dd". (e.g. 1h 45m, 250d 23h or 1y 360d).
Get	{prefix}-get-settings-label	String	Returns the label of the device. (e.g. <i>MyRelay</i>).
Set	{prefix}-get-device-blink	-	The device will blink for 5 seconds.
Set	{prefix}-get-device-blink	Boolean	The device will permanently blink.

Example: UDP=relay-set-device-blink=on =>Activate the blink setting
TCP=relay-set-device-blink=on\r\n =>Activate the blink setting

A.2.3 Relay commands

The {id} field denotes the relay port (1 - 4). For the position of the relays, the boolean value (*false*) relates to open and *true* to closed.

	Command	Argument	Description
Get	{prefix}-get-r{id}-position	Boolean	Returns a boolean with the position of the relay.
Get	{prefix}-get-r{id}-current	Integer	Returns an integer with the measured current for the relay.
Set	{prefix}-set-r{id}-position	Boolean	Sets the relay to the defined position.
Set	{prefix}-get-r{id}-toggle	-	Toggle a relay.
Set	{prefix}-get-all-toggle	-	Toggle all relays.
Set	{prefix}-get-all-position	Boolean	Sets all the relays to one position. This command respects the configured mode, meaning that if cascade is configured, the relays will all switch in cascade.

Example: UDP= relay-set-r3-position=on =>Set Relay 3 to closed
TCP= relay-set-r3-position=on\r\n =>Set Relay 3 to closed

A.2.4 Event commands

Command	Argument	Description
{prefix}-r{id}-onchange	Boolean	Indicates the status of a relay when it changes.
{prefix}-gpi-onchange	Boolean	Indicates the status of a GPI when it changes.

Appendix B

Certifications

This appendix contains the declarations of conformity and regulatory certifications applicable to the RdmRelay2.



EU Declaration of Conformity

We, **Visual Productions BV**, as the manufacturer, hereby declare under our sole responsibility that the following device:

Product Name: RdmRelay2
Product Type: Lighting Controller

complies with the requirements of the following directives and standards:

Applicable Directives:

- 2014/30/EU – Electromagnetic Compatibility (EMC)
- 2011/65/EU (as amended by 2015/863) – Restriction of Hazardous Substances (RoHS)

Applied Harmonised Standards:

- EN 61000-6-1:2019 – Electromagnetic compatibility (EMC) – Part 6-1: Generic standards – Immunity for residential, commercial, and light-industrial environments
- EN 63000:2018 – Technical documentation for the assessment of electrical and electronic products concerning the restriction of hazardous substances

This declaration is issued under the sole responsibility of the manufacturer, confirming that the object of the declaration complies with the relevant Union harmonisation legislation.

Authorised Representative:

Full name and identification of the person responsible for product quality and compliance with standards on behalf of the manufacturer:

Date: May 11, 2026
Place: Haarlem, The Netherlands



Ing. Maarten Engels
Managing Director
Visual Productions BV

Index

- About Page, 32
- AC-7b, 15
- API, 31, 38

- Backing up your data, 34
- Backup, 33
- Blink, 30, 35
- Box contents, 9

- Cascade, 26
- CE, 8, 44
- Certifications, 42
- Copyright, 4

- Data Loss, 31
- DC, 11
- Device Label, 33
- Device Management, 33
- Device Name, 33
- DHCP, 18, 31
- DIN Rail, 10
- Disposal, 9
- DMX, 13, 20

- Factory Defaults, 35
- Firmware, 33
- Firmware upgrade, 35
- Forum, 9
- Fuse, 14

- GPI, 17, 25

- Home Page, 27
- Hysteresis, 21

- Inductive, 15
- Installing vManager, 36
- IP Address, 18, 33

- Label, 30, 33
- LED, 12, 18
- Lifetime, 16

- macOS, 36
- Management, 33
- Maximum Loads, 15

- Monitor Page, 29

- Name, 33
- Network, 31
- Network Address, 18
- Network Configuration, 33
- Normally Closed, 14
- Normally Open, 14

- Password, 30
- Prefix, 32
- Pulse, 25

- RDM, 23
- Reboot, 35
- Relay, 14
- Reset Button, 19
- Resistive, 15
- Restore a Backup, 33

- Safety precautions, 5
- Sensor, 16
- Settings Page, 30
- Snap, 36
- Static IP, 18
- Status LED, 18
- Subnet mask, 18
- Switch, 25

- THRU, 13

- Ubuntu, 36
- UKCA, 8
- Unpacking, 9
- Upgrade, 33

- vManager, 18, 33

- Web-interface, 27
- Windows, 36