

DAP

USER MANUAL

ENGLISH

V1.0

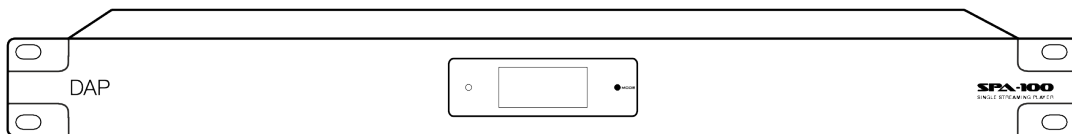

SPA-100 Streaming Pre-Amplifier

Product code: D1242

Preface

Thank you for purchasing this DAP product.

The purpose of this user manual is to provide instructions for the correct and safe use of this product.

Keep the user manual for future reference as it is an integral part of the product. The user manual shall be stored at an easily accessible location.

This user manual contains information concerning:

- Safety instructions
- Intended and non-intended use of the device
- Installation and operation of the device
- Maintenance procedures
- Troubleshooting
- Transport, storage and disposal of the device

Non-observance of the instructions in this user manual may result in serious injuries and damage of property.

©2025 DAP. All rights reserved.

No part of this document may be copied, published or otherwise reproduced without the prior written consent of Highlite International.

Design and product specifications are subject to change without prior notice.

For the latest version of this document or other language versions, please visit our website www.highlite.com or contact us at service@highlite.com.

Highlite International and its authorized service providers are not liable for any injury, damage, direct or indirect loss, consequential or economic loss or any other loss arising from the use of, or inability to use or reliance on the information contained in this document.

Highlite International B.V. – Vestastraat 2 – 6468 EX Kerkrade – the Netherlands

Table of contents

1. Introduction	4
1.1. Before Using the Product.....	4
1.2. Intended Use.....	4
1.3. Text Conventions.....	4
1.4. Symbols and Signal Words.....	5
1.5. Symbols on the Information Label.....	5
2. Safety	6
2.1. Warnings and Safety Instructions.....	6
2.2. Requirements for the User.....	7
3. Description of the Device	8
3.1. Front View.....	8
3.2. Back View.....	8
3.3. Product Specifications.....	9
3.4. Dimensions.....	10
4. Installation	11
4.1. Installation Site Requirements.....	11
4.2. Rack Mounting.....	11
4.3. Connecting the Wireless Antennas.....	11
4.4. Connecting the Device to a Router.....	11
4.5. Connecting Audio Devices.....	11
4.6. Connecting to Power Supply.....	12
4.7. Installation of the Batteries.....	12
5. Setup	13
5.1. Warnings and Precautions.....	13
5.2. Setup Example.....	13
5.3. Turning On/Off.....	13
5.4. Standby Mode.....	13
5.5. Network Setup.....	14
6. Operation	20
6.1. Safety Instructions for Operation.....	20
6.2. Operation Modes.....	20
6.2.1. Network/Wi-Fi Streaming.....	20
6.2.2. Bluetooth Streaming.....	20
6.2.3. Audio Input Playback.....	21
6.2.4. USB Playback.....	21
6.3. Mode button.....	21
6.4. Start-up.....	21
6.5. Wi-Fi Control.....	22
6.5.1. 4STREAM App Browse Tab.....	22
6.5.2. 4STREAM App Device Tab.....	23
6.5.2.1. Rename.....	23
6.5.2.2. Speaker Info.....	25
6.5.2.3. Alarm Clock.....	26
6.5.2.4. Preset Content.....	27
6.5.2.5. Sleep Timer.....	28
6.5.2.6. Audio Settings.....	28
6.5.2.7. EQ.....	28
6.5.3. 4STREAM App Search Tab.....	28
6.5.4. 4STREAM App Settings Tab.....	28
6.6. Functions of the Remote Control Buttons.....	29
7. Troubleshooting	30
8. Maintenance	31
8.1. Safety Instructions for Maintenance.....	31
8.2. Preventive Maintenance.....	31
8.2.1. Basic Cleaning Instructions.....	31
8.3. Corrective Maintenance.....	31

9. Deinstallation, Transportation and Storage	31
10. Disposal	32
11. Approval	32

1. Introduction

1.1. Before Using the Product



Important

Read and follow the instructions in this user manual before installing, operating or servicing this product.

The manufacturer will not accept liability for any resulting damages caused by the non-observance of this manual.

After unpacking, check the contents of the box. If any parts are missing or damaged, contact your Highlite International dealer.

Your shipment includes:

- DAP SPA-100 Streaming Pre-Amplifier
- Schuko to IEC power cable (1,5 m)
- 2 wireless antennas
- IR remote control
- User manual

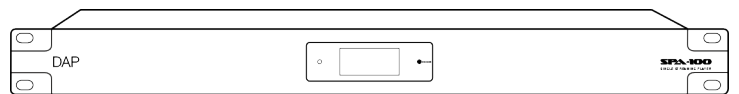
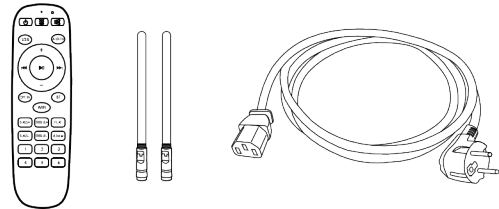

Figure 1



1.2. Intended Use

This device is intended for professional use as a streaming preamplifier. It can be used only indoors. This device is not suitable for households.

Any other use, not mentioned under intended use, is regarded as non-intended and incorrect use.

1.3. Text Conventions

Throughout the user manual the following text conventions are used:

- Buttons: All buttons are in bold lettering, for example "Press the **UP/DOWN** buttons"
- References: References to parts of the device are in bold lettering, for example: "turn the **adjustment handle (05)**". References to chapters are hyperlinked
- 0–255: Defines a range of values
- Notes: **Note:** (in bold lettering) is followed by useful information or tips

1.4. Symbols and Signal Words

Safety notes and warnings are indicated throughout the user manual by safety signs.

Always follow the instructions provided in this user manual.



DANGER

Indicates an imminently hazardous situation which, if not avoided, will result in death or serious injury.



WARNING

Indicates a potentially hazardous situation which, if not avoided, could result in death or serious injury.



CAUTION

Indicates a potentially hazardous situation, which, if not avoided, may result in minor or moderate injury.



Attention

Indicates important information for the correct operation and use of the product.



Important

Read and observe the instructions in this document.



Electrical hazard



Provides important information about the disposal of this product.

1.5. Symbols on the Information Label

This product is provided with an information label. The information label is located on the bottom plate of the device.

The information label contains the following symbols:



This device is designed for indoor use.



This device falls under IEC protection class I.



This device shall not be treated as household waste.



Caution: Risk of electric shock. Disconnect input power before opening.
Warning: This appliance must be earthed.

2. Safety



Important
Read and follow the instructions in this user manual before installing, operating or servicing this product.

The manufacturer will not accept liability for any resulting damages caused by the non-observance of this manual.

2.1. Warnings and Safety Instructions



DANGER
Danger for children

For adult use only. The device must be installed beyond the reach of children.

- Do not leave any parts of the packaging (plastic bags, polystyrene foam, nails, etc.) within the reach of children. Packaging material is a potential source of danger for children.



DANGER
Electric shock caused by short-circuit

This device falls under IEC protection Class I.

- Make sure that the device is electrically connected to ground (earth). Connect the device only to a socket-outlet with a ground (earth) connection.
- Do not cover the ground (earth) connection.
- Do not let the power cable come into contact with other cables. Handle the power cable and all connections with the mains with caution.
- Do not modify, bend, mechanically strain, put pressure on, pull or heat up the power cable.
- Make sure that the power cable is not crimped or damaged. Examine the power cable periodically for any defects.
- Do not immerse the device in water or other liquids. Do not install the device in a location where flooding may occur.
- Do not use the device during thunderstorms. Disconnect the device from the electrical power supply immediately.



DANGER
Electric shock caused by dangerous voltage inside

There are areas inside the device where dangerous touch voltage may be present.

- Do not open the device or remove any covers.
- Do not operate the device if the covers or the housing are open. Before operation, check if the housing is firmly closed and all screws are tightly fastened.
- Disconnect the device from the electrical power supply before service and maintenance, and when the device is not in use.



Attention
Power supply

- Before connecting the device to the power supply, make sure that the current, voltage and frequency match the input voltage, current and frequency specified on the information label on the device.

- Make sure that the cross-sectional area of the extension cords and power cables is sufficient for the required power consumption of the device.



Attention
General safety

- Do not shake the device. Avoid brute force when installing or operating the device.
- If the device is dropped or struck, disconnect the device from the electrical power supply immediately.
- If the device is exposed to extreme temperature variations (e.g. after transportation), do not switch it on immediately. Let the device reach room temperature before switching it on, otherwise it may be damaged by the formed condensation.
- If the device fails to work properly, discontinue use immediately.



Attention
For professional use only
This device must be used only for the purposes it is designed for.

This device is designed to be used as a streaming preamplifier. Any incorrect use may lead to hazardous situations and result in injuries and material damage.

- This device is not suitable for households.
- This device does not contain user-serviceable parts. Unauthorized modifications to the device will render the warranty void. Such modifications may result in injuries and material damage.



Attention
Do not expose the device to conditions that exceed the rated IP class conditions.

This device is IP20 rated. IP (Ingress Protection) 20 class provides protection against solid objects greater than 12 mm, such as fingers, and no protection against harmful ingress of water.

2.2. Requirements for the User

This product may be used by ordinary persons. Maintenance may be carried out by ordinary persons. Installation and service shall be carried out only by instructed or skilled persons. Contact your Highlite International dealer for more information.

Instructed persons have been instructed and trained by a skilled person, or are supervised by a skilled person, for specific tasks and work activities associated with the installation, service and maintenance of this product, so that they can identify risks and take precautions to avoid them.

Skilled persons have training or experience, which enables them to recognize risks and avoid hazards associated with the installation, service and maintenance of this product.

Ordinary persons are all persons other than instructed persons and skilled persons. Ordinary persons include not only users of the product but also any other persons that may have access to the device or who may be in the vicinity of the device.

3. Description of the Device

The DAP SPA-100 Streaming Pre-Amplifier is a casting media player that can be installed into a 19-inch rack. In addition to an audio input, it has Bluetooth 5.0 with aptX HD support and has a USB/MP3 player that supports AAC, AAC+, ALAC, APE, FLAC, MP3 and WAV file formats.

3.1. Front View

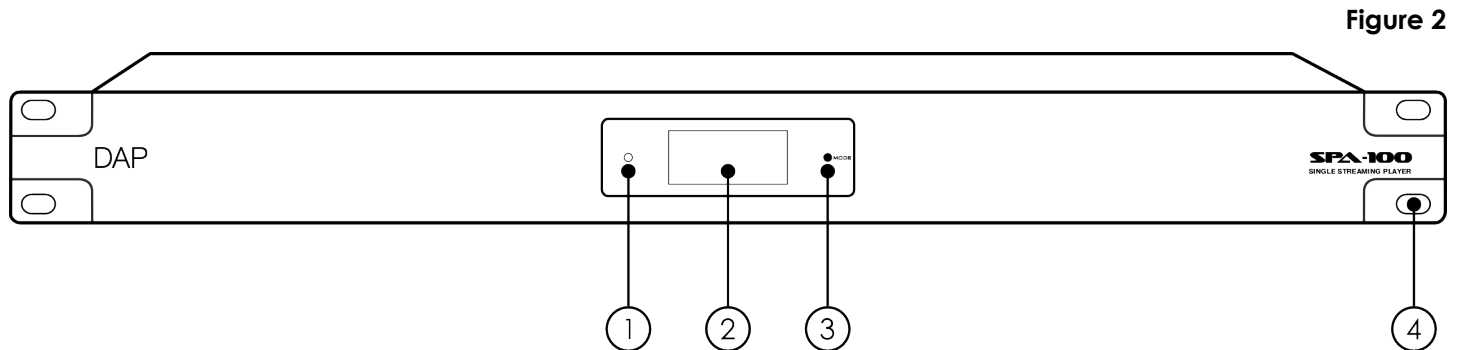

Figure 2

- 01) LED indicator
- 02) OLED display (1,4")
- 03) Mode button
- 04) 4 x mounting openings (for installation in a 19" rack)

3.2. Back View

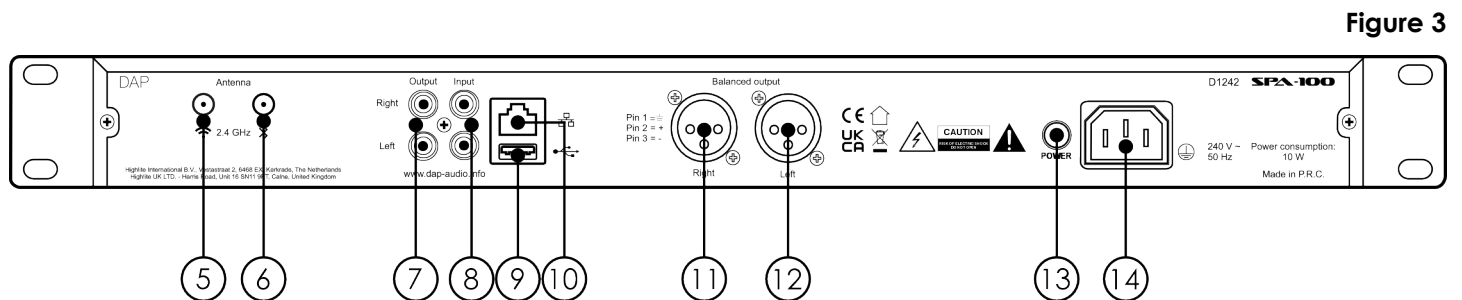

Figure 3

- 05) Wi-Fi antenna connector
- 06) Bluetooth antenna connector
- 07) RCA analog line-level connectors OUT (Left/Right)
- 08) RCA analog line-level connectors IN (Left/Right)
- 09) USB-A port
- 10) RJ45 LAN connector IN
- 11) 3-pin XLR balanced connector OUT (Right)
- 12) 3-pin XLR balanced connector OUT (Left)
- 13) Power switch ON/OFF
- 14) IEC power connector IN

3.3. Product Specifications

Model:	SPA-100 Streaming Pre-Amplifier
Inputs:	
Stereo Inputs	1
Stereo Input Connector	RCA
Outputs:	
Main Outputs	1
Main Output Connector	3-pin XLR / RCA
Playback:	
Supported Audio Files	AAC/AAC+ / ALAC / APE / FLAC / MP3 / WAV
Supported Format	exFAT / FAT16 / FAT32
Maximum Storage Size	128 GB
Media Input/Output	USB-A
USB Type	2.0
Playback Functions	Up (Skip) / Down (Skip) / Play / Pause / Stop
Audio Specifications:	
THD Level	< 0.03 %
Signal-to-noise Ratio	> 110 dB
Frequency Response Minimum	20 Hz
Frequency Response Maximum	20000 Hz
Wireless Specifications:	
Bluetooth Version	5.0
Bluetooth Classification	2
Bluetooth Audio Profile	aptX HD
Bluetooth Range	15 m
Carrier Frequency	2,4 GHz
Control and Programming:	
Control Mode	App
Display	OLED
Display Size	1,4 "
Electrical Specifications and Connections:	
Power Supply	240 V AC 50 Hz
Power Consumption	10 W
SMPS	No
Power Connector In	IEC
Data Connector In	RJ45
Mechanical Specifications:	
Height	44,5 mm
Depth	110 mm

Width	483 mm
Flightcase Size	19"
Rack Units	1 U
Housing	Steel
Colour	Black
Weight	1,51 kg
IP Rating	IP20 (indoor use only)

Thermal Specifications:

Minimum Ambient Temperature	0 °C
-----------------------------	------

Included Items:

Included Cables	IEC cable
Included Remotes	IR Remote battery not included

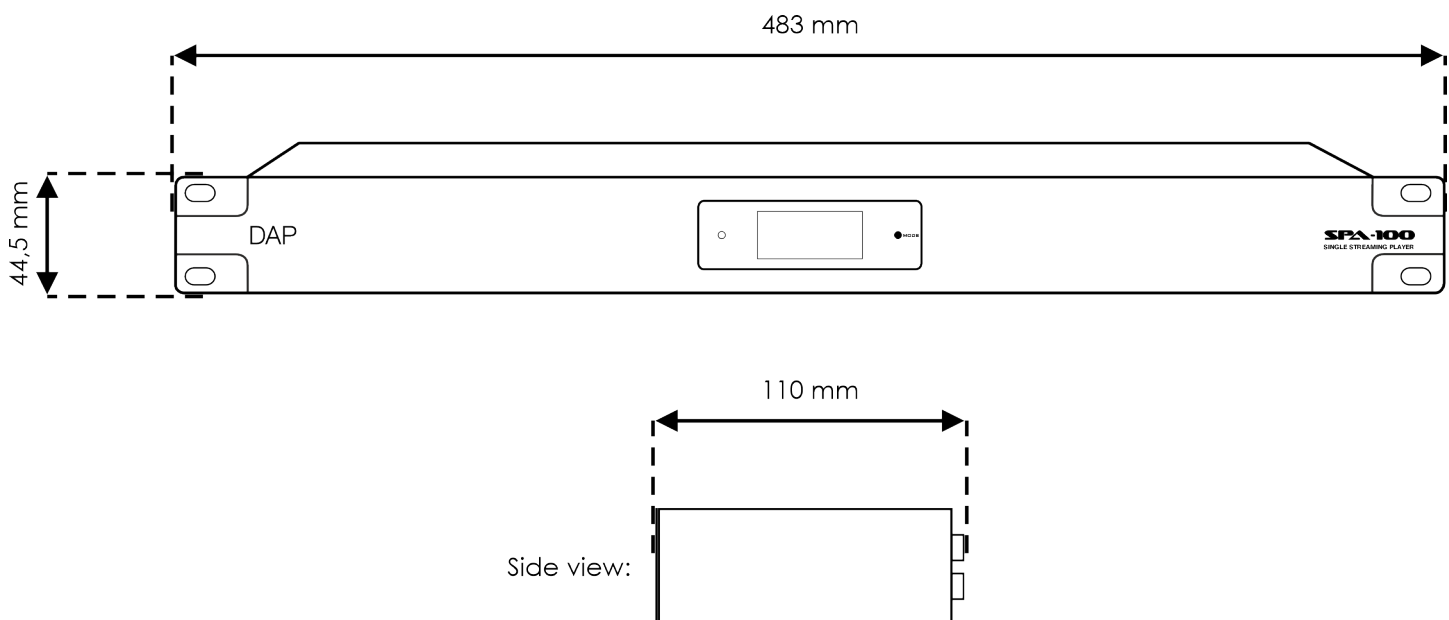
3.4. Dimensions**Figure 4**

4. Installation

4.1. Installation Site Requirements

- The device can be used only indoors.
- The minimum distance to other objects must be bigger than 0,5 m.
- The maximum ambient temperature $t_a = 40\text{ °C}$ must never be exceeded.
- The relative humidity must not exceed 50 % with an ambient temperature of 40 °C.

4.2. Rack Mounting

The device can be mounted in a standard 19-inch rack. The device requires 1 rack unit (RU) of space, which is 44,5 mm high.

Make sure that the rack is sufficiently secured to prevent it from becoming unstable or falling over.

To mount the device in a two-post rack, follow the steps below:

- 01) Insert 4 cage nuts in the openings on the rack posts where you want to mount the device.
- 02) Position the device in front of the rack posts so that the 4 **mounting openings (04)** on the flanges face the openings on the rack posts with cage nuts.
- 03) Use a screwdriver to mount the device to the rack posts with 4 screws.

4.3. Connecting the Wireless Antennas

The device is delivered with 2 wireless antennas. The antennas are not connected. To install the antennas:

- 01) Put the 2 wireless antennas into the **Wi-Fi antenna connector (05)** and the **Bluetooth antenna connector (06)**.
- 02) Turn the 2 wireless antennas clockwise to tighten them.
- 03) Make sure that the wireless antennas point up.

4.4. Connecting the Device to a Router

To make a LAN connection, it is necessary to connect the device to a router.

- 01) Plug one end of the network cable into an RJ45 connector on the router.
- 02) Plug the other end of the network cable into the **RJ45 LAN connector IN (10)** on the device.

Note:

If you use a network cable and the DHCP function on the router is activated, it is not necessary to configure the network.

4.5. Connecting Audio Devices

The device has 1 unbalanced RCA analog input (L + R), 1 unbalanced RCA analog output (L + R) and 1 balanced XLR output (L + R).

Turn off the SPA-100 when connecting audio devices in order to avoid interference.

- Use a suitable cable to connect an audio input device (a phone, a tablet, a computer etc.) to the **RCA analog line-level connector IN (Left/Right) (08)**.
- Use a suitable cable to connect an audio output device (an active speaker, an amplifier, etc.) to the **RCA analog line-level connector OUT (Left/Right) (07)** or the **3-pin XLR balanced connector outputs (11 and 12)**.

Note:

Compatible audio input devices can also be connected with Bluetooth (see [6.2.2. Bluetooth Streaming](#) on page 20).

4.6. Connecting to Power Supply



DANGER
Electric shock caused by short-circuit

The device accepts AC mains power at 240 V and 50 Hz. Do not supply power at any other voltage or frequency to the device.

This device falls under IEC protection class I. Make sure that the device is always electrically connected to the ground (earth).

Before connecting the device to the socket-outlet:

- Make sure that the power supply matches the input voltage specified on the information label on the device.
- Make sure that the socket-outlet has a ground (earth) connection.

Connect the device to the socket-outlet with the power plug.

4.7. Installation of the Batteries

The device can be operated with an IR remote control. The remote control is included in the delivery.

The remote control is delivered without batteries. It accepts 2 x AAA 1,5 V (alkaline) batteries.

To install the batteries:

- 01) Press on the battery compartment cover and slide it downwards to open the battery compartment.
- 02) Insert 2 x AAA 1,5 V batteries into the battery housing. Make sure that you install the batteries with correct polarity orientation.
- 03) Close the battery compartment cover.

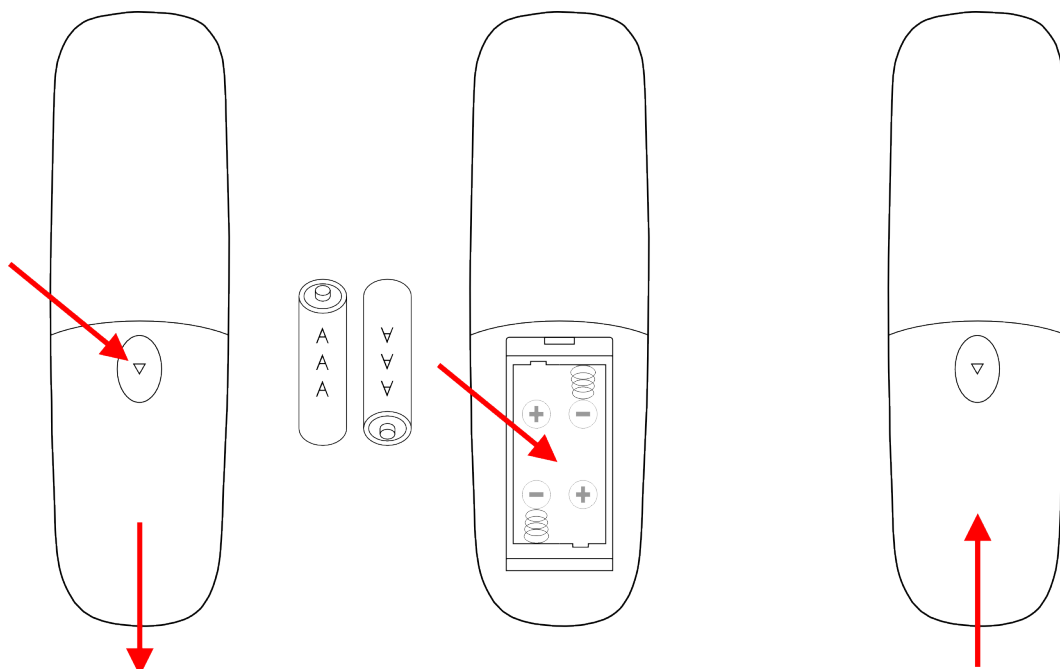

Figure 5

5. Setup

5.1. Warnings and Precautions



Attention

Connect all data cables before supplying power.

Disconnect power supply before connecting or disconnecting data cables.

5.2. Setup Example

The figure below shows a typical setup with 2 streaming devices and 2 active speakers connected through an amplifier to the device.

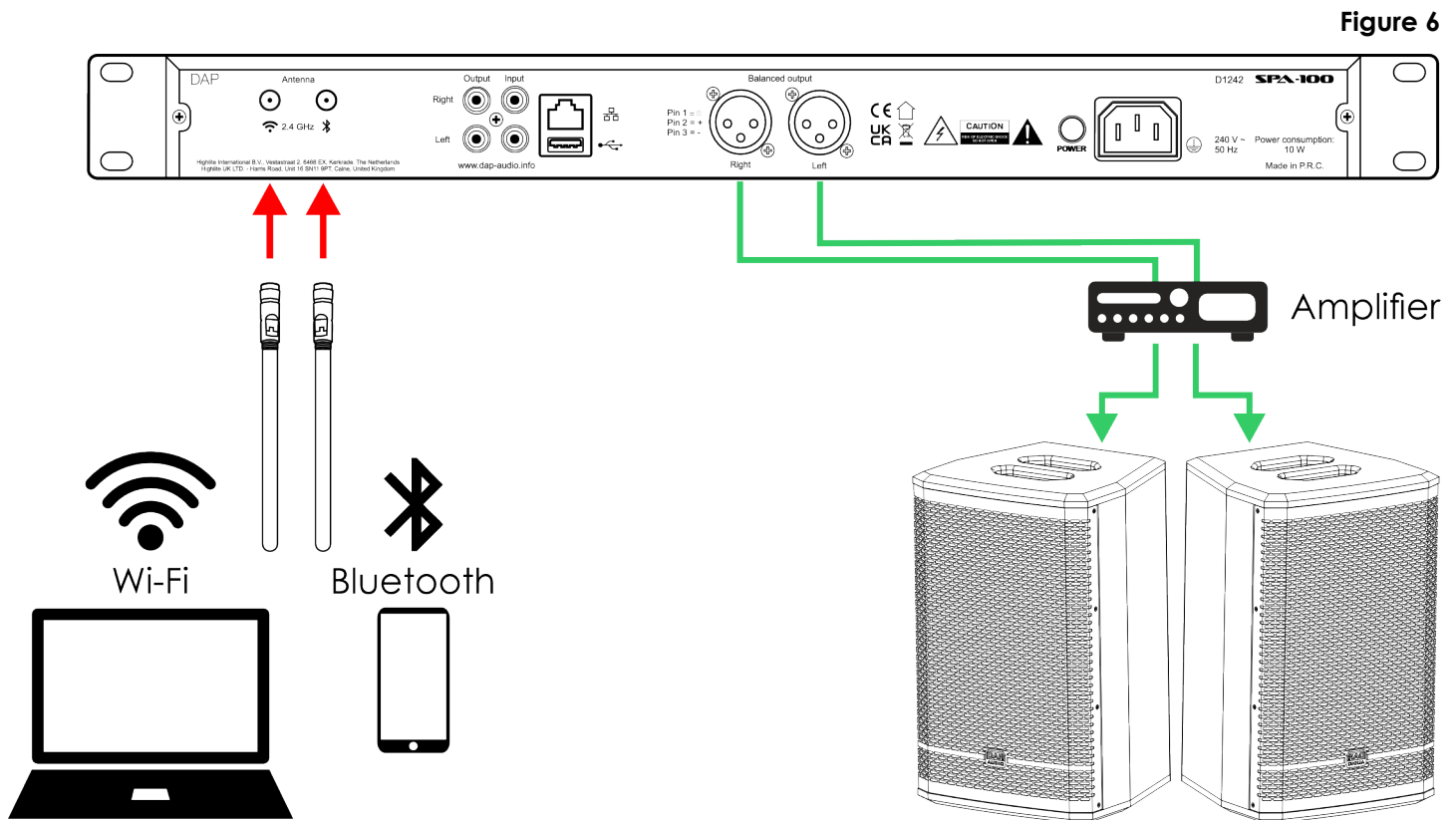

5.3. Turning On/Off

The device has a power switch.

- To turn the device on, set the **power switch (13)** to ON position.
- To turn the device off, set the **power switch (13)** to OFF position.

Make sure that the device is turned off with the **power switch (13)** when not in use.

5.4. Standby Mode

The device has a 'standby' mode.

- To enter 'standby' mode, press and hold the **Mode button (03)** for 5 seconds or press the standby button on the remote control (see [6.6. Functions of the Remote Control Buttons](#) on page 29). In standby mode, the **LED indicator (01)** turns red.
- To exit 'standby' mode, press the **mode button (03)** once or press the standby button on the remote control.

5.5. Network Setup

You can connect the SPA-100 directly to a network with a CAT-5e or CAT 6 cable. Internet access is automatic. No further action is necessary.

To connect the SPA-100 to a network via Wi-Fi, follow the steps below:

1) Install the 4STREAM app on your Android or iOS device.

Note:

The 4STREAM app is also needed to control the device via Wi-Fi.



- 2) On your device, make sure that Wi-Fi, Bluetooth and Location are turned on.
- 3) Open the 4STREAM app on your device.
- 4) Press 'Add Device'.

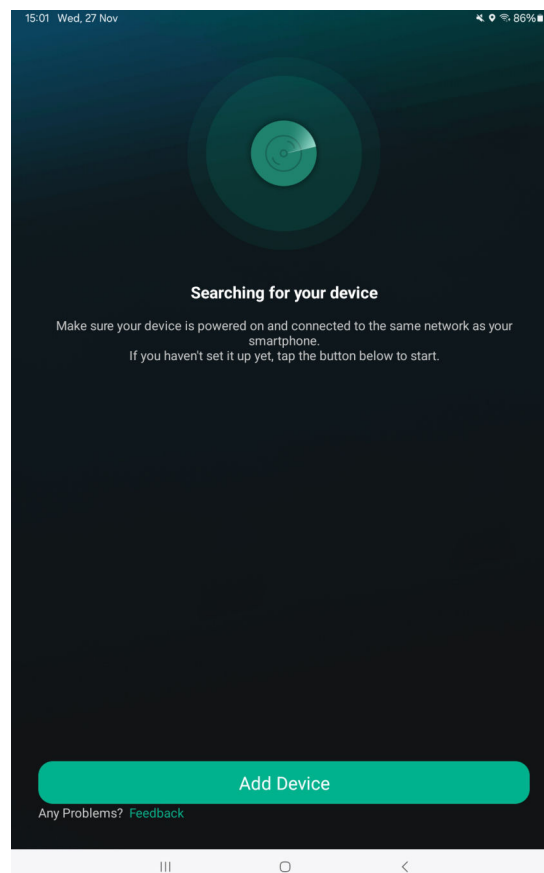

5) Press 'indicator is blinking'.

Note: The indicator on the SPA-100 does not blink!

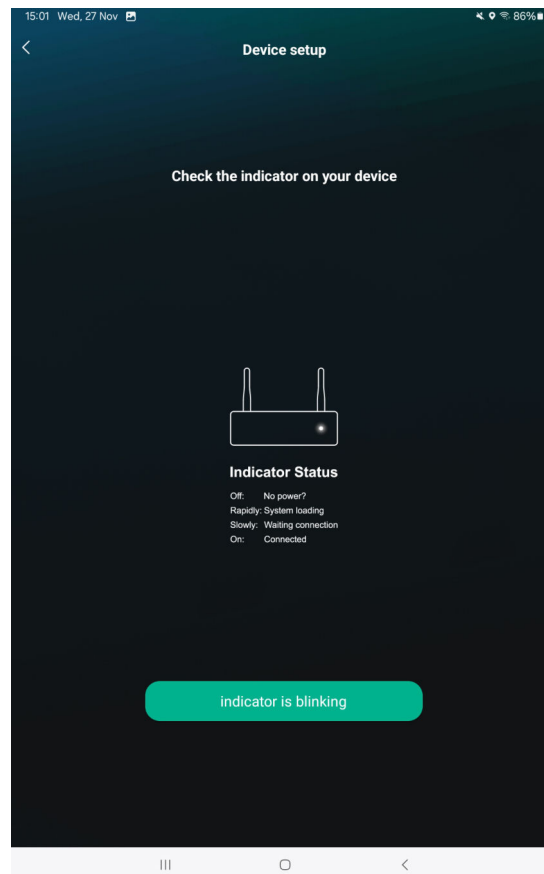

6) Press 'pair via wifi'.

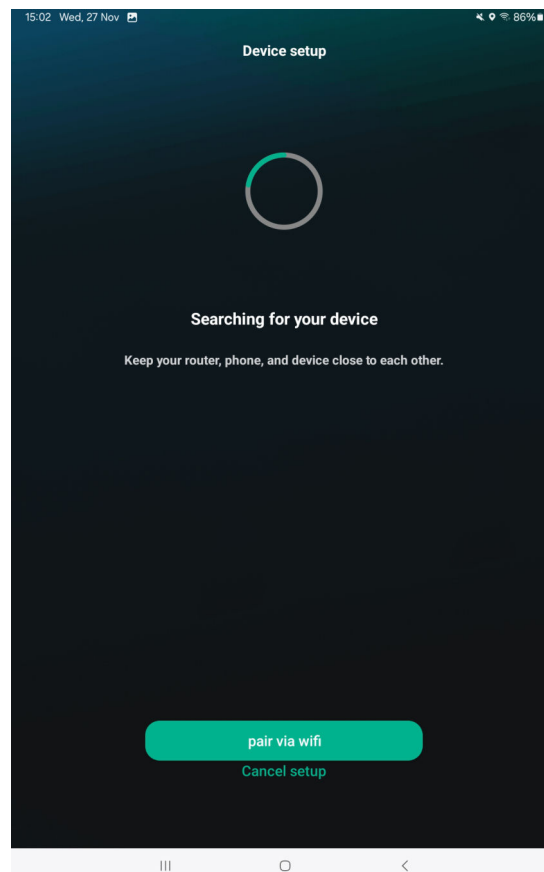

7) Press 'Settings'.

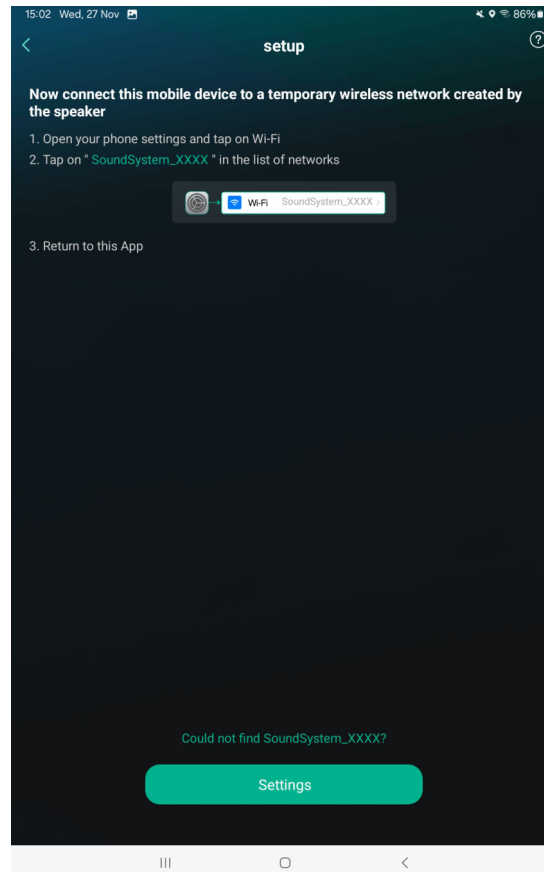

8) Select the SPA-100 in available networks.

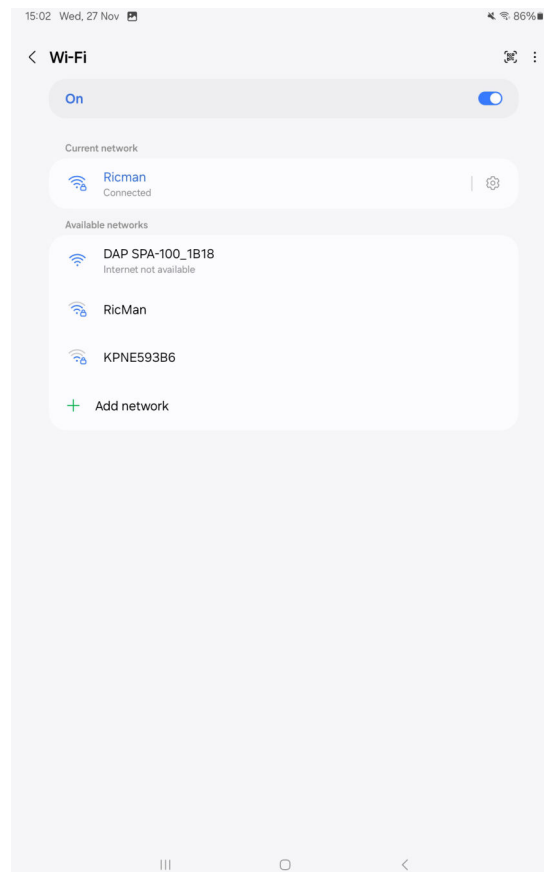

9) Following the internet quality check, press 'Connect only this time' or 'Always connect'.

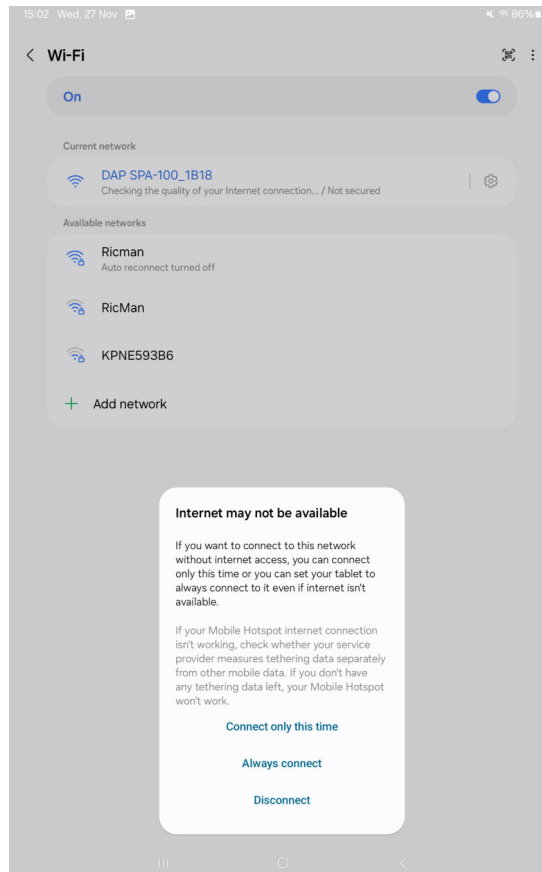

10) Return to the app.

11) If required, enter the Wi-Fi network password of your chosen network.

Note:

Press 'Change Wi-Fi' to select a different Wi-Fi network.

12) Press 'Continue'.

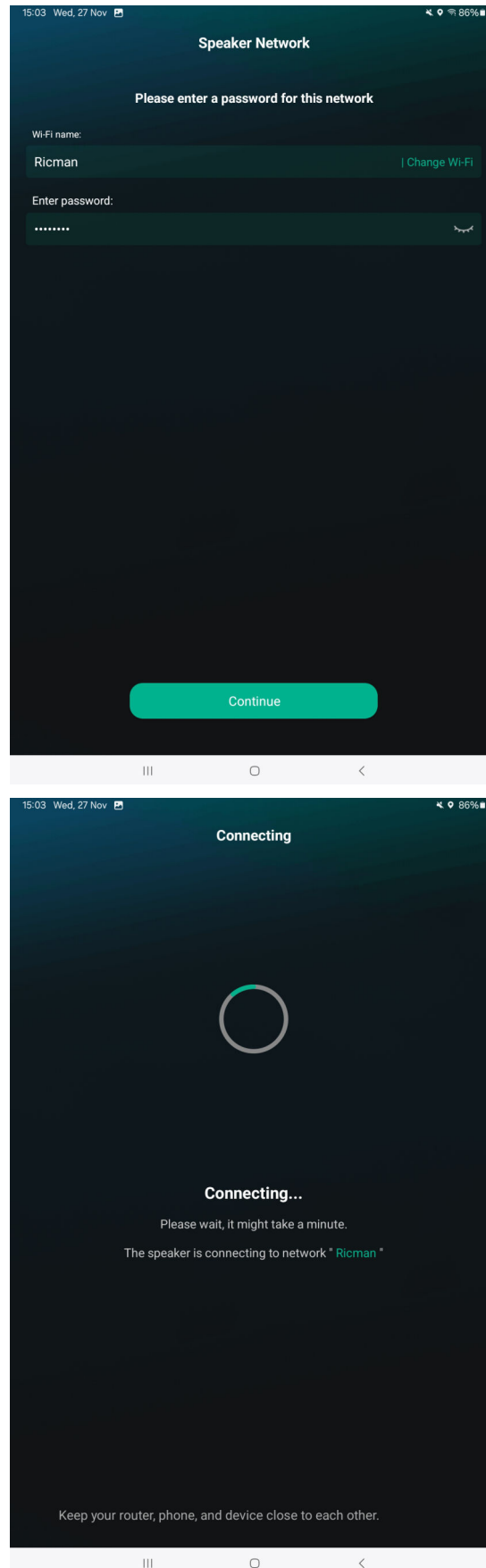

13) Press 'Settings' to connect your device to the same network as the SPA-100.

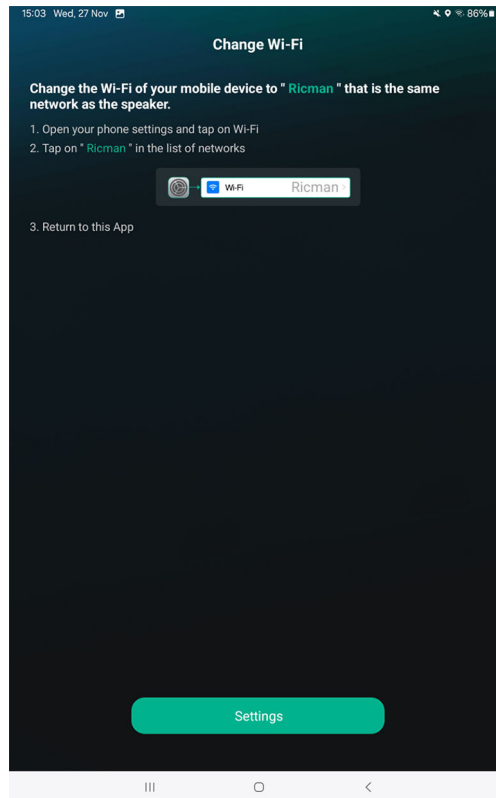

14) Return to the app.

The device will now connect to your network.

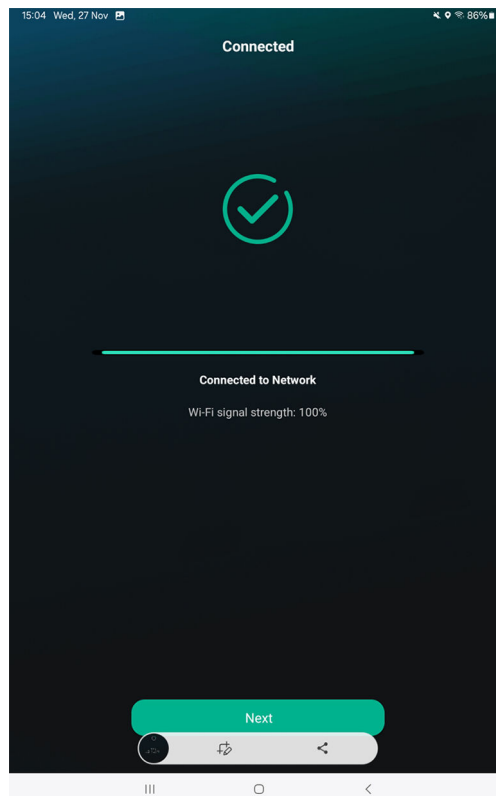

15) Press 'Next' to name the device (see [6.5.2.1. Rename](#) on page 23).

The device can now be controlled via Wi-Fi (see [6.5. Wi-Fi Control](#) on page 22).

6. Operation

6.1. Safety Instructions for Operation



Attention

This device must be used only for the purposes it is designed for.

This device is intended for professional use as a streaming preamplifier. It can be used only indoors. This device is not suitable for households.

Any other use, not mentioned under intended use, is regarded as non-intended and incorrect use.



Attention

Power supply

Before connecting the device to the power supply, make sure that the current, voltage and frequency match the input voltage, current and frequency specified on the information label on the device.

6.2. Operation Modes

To use all modes on the device, it is necessary to establish a network connection (see [5.5. Network Setup](#) on page 14).

The SPA-100 supports the following operation modes:

- Network/Wi-Fi streaming (see [6.2.1. Network/Wi-Fi Streaming](#))
- Bluetooth streaming (see [6.2.2. Bluetooth Streaming](#))
- Audio input playback (see [6.2.3. Audio Input Playback](#))
- USB playback (see [6.2.4. USB Playback](#))

6.2.1. Network/Wi-Fi Streaming

Network/Wi-Fi streaming is only available after the network has been set up. The 4STREAM app is needed to control the device via Wi-Fi (see [5.5. Network Setup](#) on page 14).

6.2.2. Bluetooth Streaming

In this mode, you can stream sound from a Bluetooth device.

To stream sound, connect your Bluetooth device to the SPA-100 by following the steps below:

01) Press the **mode button (01)** on the SPA-100 until the Bluetooth symbol appears.

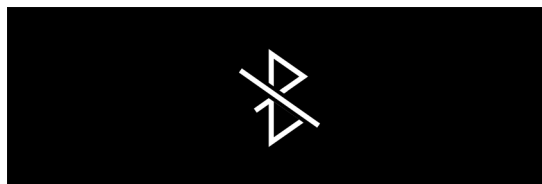

02) Enable Bluetooth on your Bluetooth device.

03) Scan for available devices on your Bluetooth device. The ID of the SPA-100 is 'SoundSystem'.

04) Press 'SoundSystem' on your Bluetooth device to begin pairing.

05) When prompted, press 'Pair' on your Bluetooth device.

After pairing, sound can be streamed from your Bluetooth device to the the SPA-100 via Bluetooth.

Note:

After pairing the voice prompt says "Power On, Apt-X Classic".

6.2.3. Audio Input Playback

In this mode, you can play sound from an external audio device on the SPA-100.

The external audio device and the SPA-100 need to be connected with a cable that has connectors suitable for both devices. The audio input connectors on the SPA-100 are RCA.

To connect an external audio device to the SPA-100, follow the steps below:

- 01) Connect a cable with suitable connectors to the audio outputs on your external audio device.
- 02) Connect the RCA connectors on the cable to the **RCA analog line-level connectors IN (Left/Right) (08)** on the SPA-100.
- 03) Press the **mode button (01)** until the audio input symbol appears.

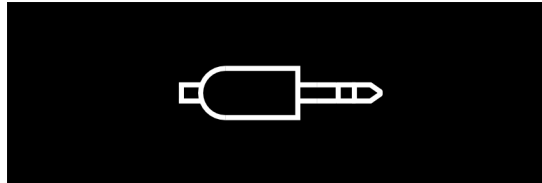

After connecting the devices, sound can be played from your external audio device to the SPA-100.

6.2.4. USB Playback

In this mode, you can play sound via a USB drive.

To play sound via USB, insert a USB drive into the **USB-A port (09)**.

The SPA-100 will automatically switch to USB mode and sound will start to play automatically.

Note:

The USB player mode overrides all other modes on the SPA-100.

The SPA-100 is compatible with USB drives (max. capacity 128 GB) formatted to exFAT / FAT16 / FAT32 and supports the following file formats:

AAC / AAC+ / ALAC / APE / FLAC / MP3 / WAV

6.3. Mode button

Press the **mode button (01)** once to cycle through the following modes:

- Network/Wi-Fi streaming
- Bluetooth streaming
- Audio input playback

- Press and hold the **mode button (01)** for 5 seconds to enter standby mode.
- Double press the **mode button (01)** to reset the network.
- Triple press the **mode button (01)** to restore the factory settings.

Note:

USB playback starts automatically when a USB drive is inserted into the **USB-A port (09)**.

6.4. Start-up

Upon start-up, the device searches for a network.

If the device is connected to a router with a network cable, internet access is automatic. No further action is necessary.

When you start the device for the first time and you want to use a wireless network, it needs to be configured (see [5.5. Network Setup](#) on page 14). You need to perform this action only once.

6.5. Wi-Fi Control

The SPA-100 can be controlled with Wi-Fi via the 4STREAM app after it has been configured (see [5.5. Network Setup](#) on page 14).

6.5.1. 4STREAM App Browse Tab

From the browse tab, you can preset content (see [6.5.2.4. Preset Content](#) on page 27), access your library and music services, and select sources on the device.

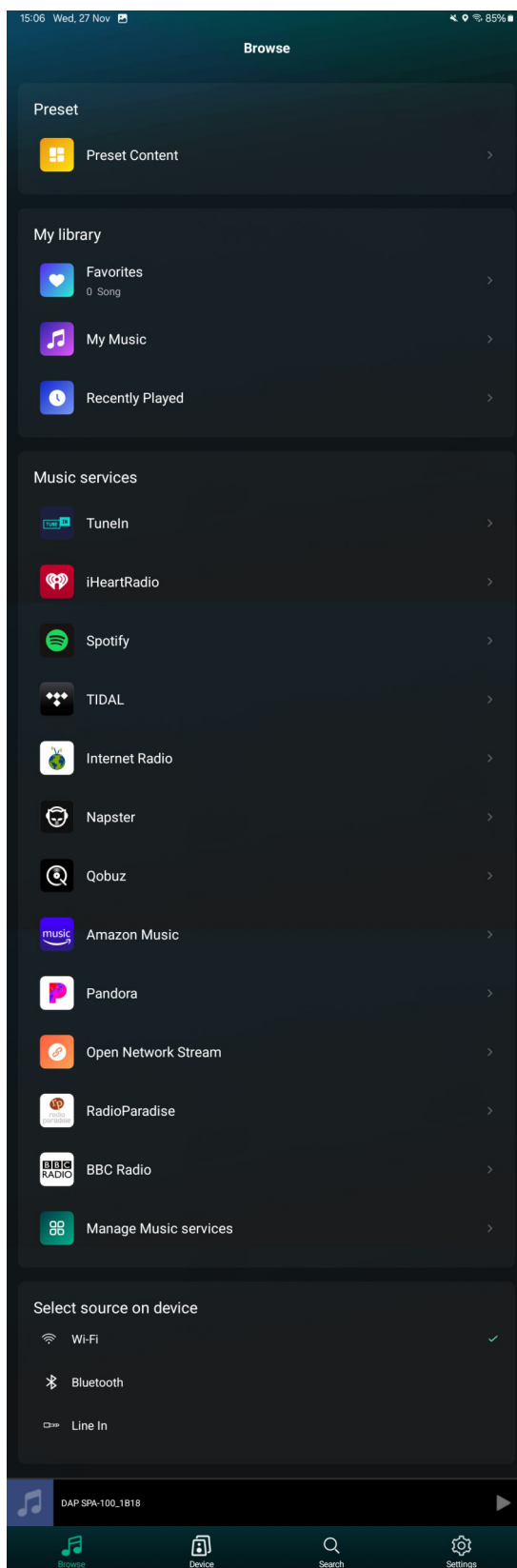

6.5.2. 4STREAM App Device Tab

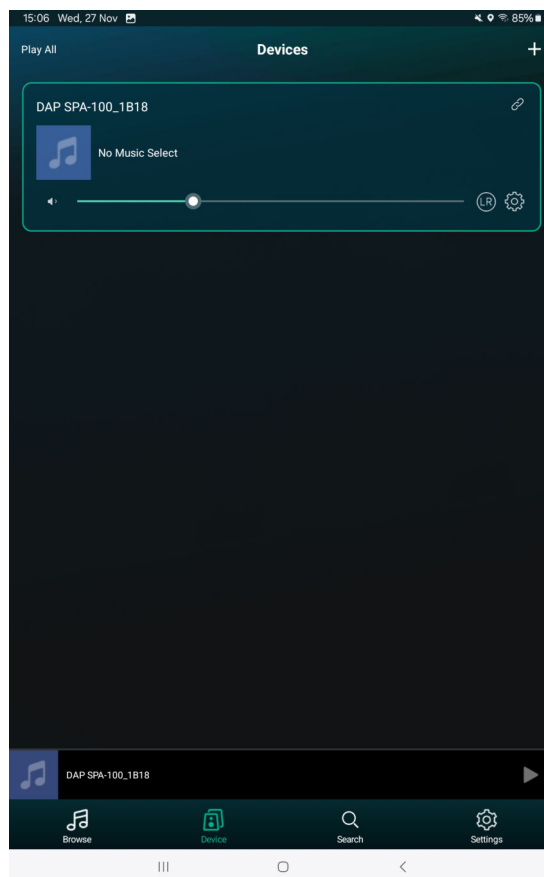

In the app device tab, you can add new devices to the setup, synchronize play, adjust the volume, select left, right and stereo channels and access the following settings by pressing the settings icon:

- Rename (see [6.5.2.1. Rename](#))
- Speaker Info (see [6.5.2.2. Speaker Info](#))
- Alarm Clock (see [6.5.2.3. Alarm Clock](#))
- Present Content (see [6.5.2.4. Preset Content](#))
- Sleep Timer (see [6.5.2.5. Sleep Timer](#))
- Audio Settings (see [6.5.2.6. Audio Settings](#))
- EQ (see [6.5.2.7. EQ](#))

6.5.2.1. Rename

This screen shows the current device name and preset names.

The device name can be set to a custom name or one of the following preset names:

- DAP SPA-100_1B18 (recommended name)
- Bedroom
- Living Room
- Library
- Kitchen
- Bathroom
- Office
- Den
- Dining Room
- Family Room
- Foyer
- Garage
- Garden
- Guest Room
- Hallway

- Master Room
- Media Room
- Patio
- Playroom
- Pool
- Portable
- TV Room

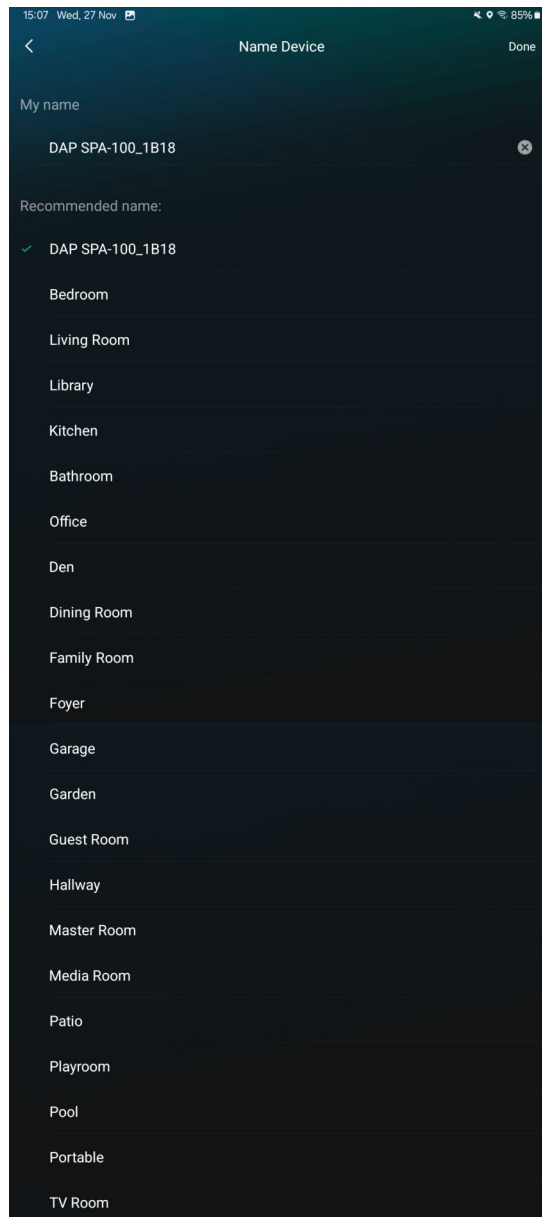

To set the device name:

- 01) Press on the existing name to enter a custom name, or;
- 02) Press a preset name.
- 03) Press 'Done' on the top right of the screen.

Note:

If naming the device immediately after network setup, press '>' on the top right of the screen after choosing the preset name.

6.5.2.2. Speaker Info

This screen shows the speaker info.

From this screen, it is also possible to set up a personal hotspot, change the audio prompts language and restore factory settings.

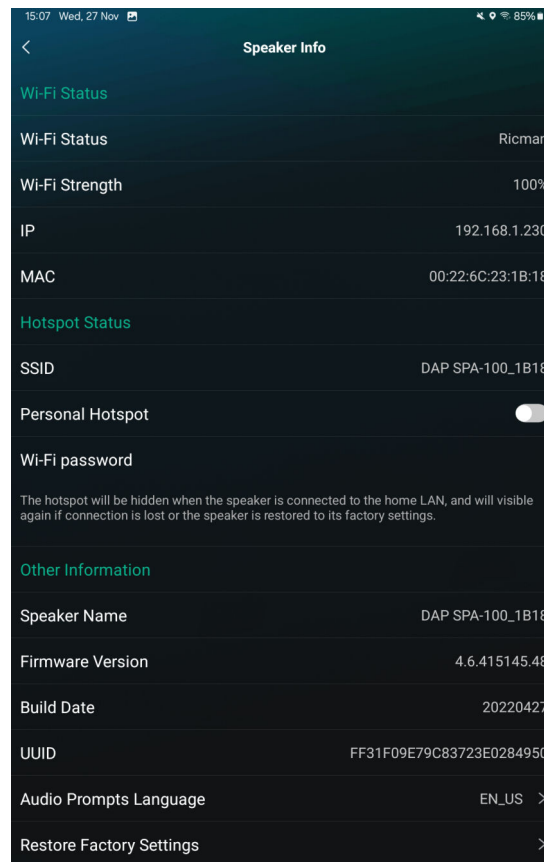

To setup a personal hotspot:

- 01) Press the 'Personal Hotspot' button.
- 02) Enter a Wi-Fi password.
- 03) Press Done.

To change the audio prompts language:

- 01) Press 'Audio Prompts Language'
- 02) Select Chinese or English.

To restore factory settings:

- 01) Press 'Restore Factory Settings'.
- 02) Press Confirm to restore factory settings.

6.5.2.3. Alarm Clock

This screen shows the alarm clock.

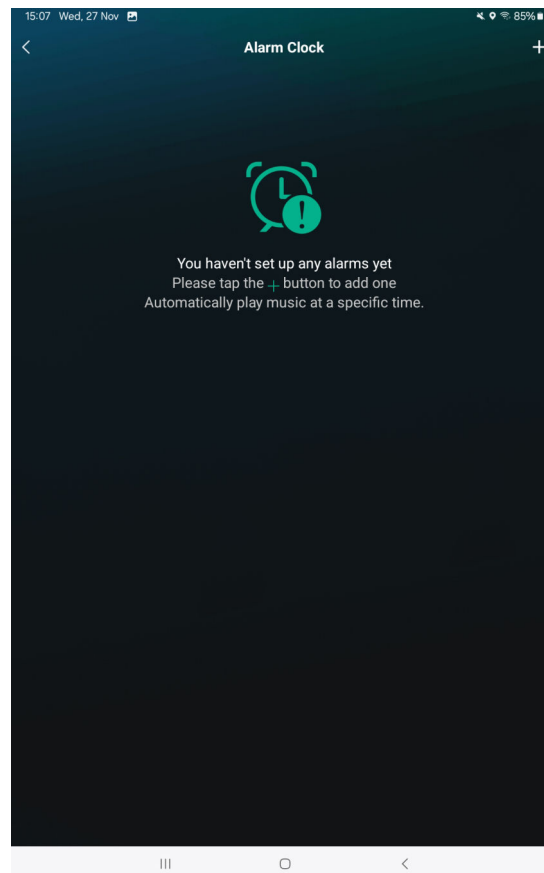

To add an alarm:

1) Press '+' in the top right corner.

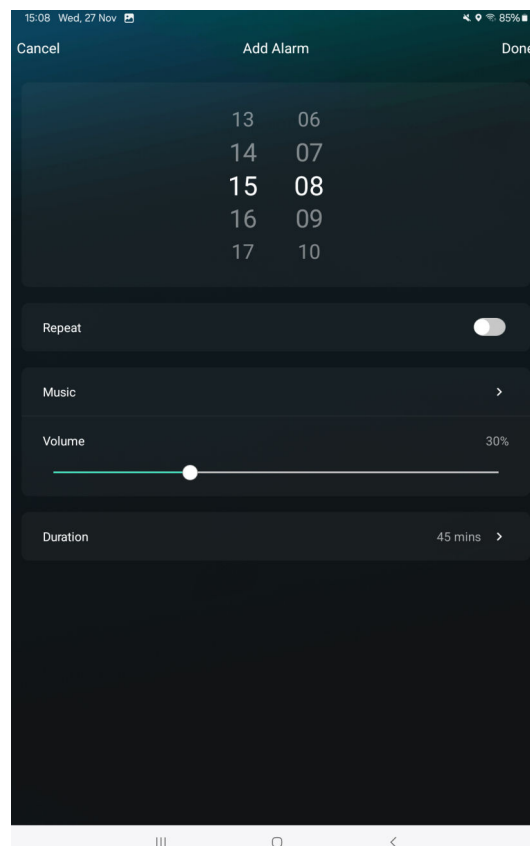

- 2) Set the hours and minutes.
- 3) Press the 'Repeat' button to choose specific days of the week.
- 4) Press 'Music' to select the sound source.
- 5) Set the volume using the slide control.
- 6) Press 'Duration' to set the duration. Press the 'No limit' button for no duration or press 'Duration' to select hours and minutes.

Note:

To delete an alarm:

- 1) Swipe left on the alarm to be deleted.
- 2) Press delete.

6.5.2.4. Preset Content

This screen shows the preset content.

To preset content from any music service that is currently playing:

- 01) Go to the device tab.
- 02) Press on the content in the window.
- 03) Press on the 3 dots.

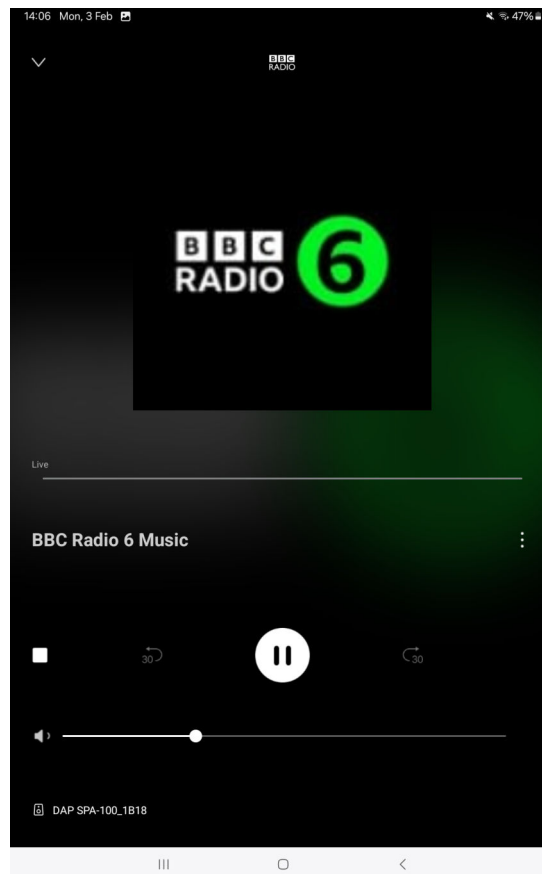

- 04) Press on 'Preset'.
- 05) Select an empty preset slot.

Note:

To delete a preset:

- 01) Open Preset Content.
- 02) Press 'Edit'.
- 03) Select the presets to delete.
- 04) Press the delete symbol.

6.5.2.5. Sleep Timer

To set the sleep timer:

- 01) Press the 'Sleep Timer' button.
- 02) Select 10Min, 20Min, 30Min, 60Min or 90Min with the sliding bar.

6.5.2.6. Audio Settings

To turn the Fade-In and Fade-Out Effects on and off, press the Fade-In and Fade-Out Effects button.

6.5.2.7. EQ

To adjust the EQ:

- 01) Use the Treble slide control to adjust the treble. The adjustment range is -5 to +5 dB.
- 02) Use the Bass slide control to adjust the bass. The adjustment range is -5 to +5 dB.

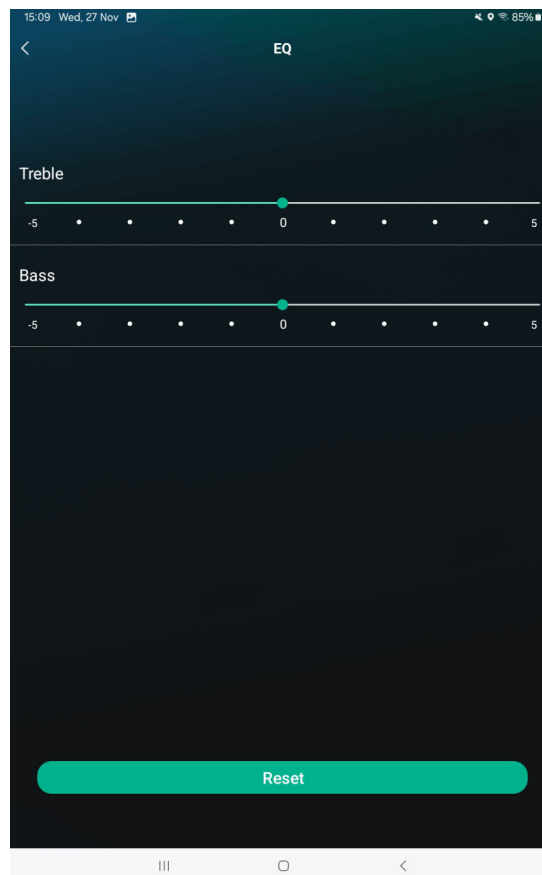

6.5.3. 4STREAM App Search Tab

From the search tab, you can search for artists, songs, albums, playlists, stations and shows.

Search by following the steps below:

- 01) Select the category you want to search.
- 02) Enter a search term into the search bar and press enter.

6.5.4. 4STREAM App Settings Tab

From the settings tab, you can view the app version and send feedback.

6.6. Functions of the Remote Control Buttons

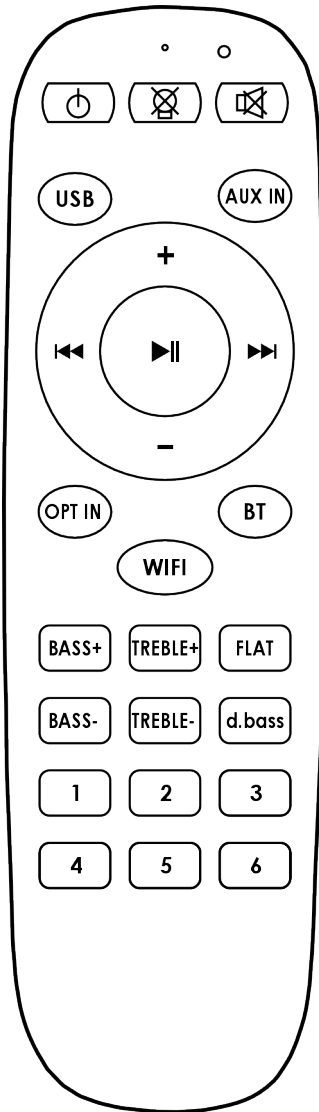

Button	Description	Function
	On/Off	Turns standby mode on/off
	Brightness	Changes the display brightness
	Mute	Turns mute on/off
	USB	Turns USB mode on
	Aux in	Turns audio input mode on
	Volume +	Increases the volume
	Skip backwards	Skips to the beginning of a track or a previous track
	Play/pause	Plays or pauses content
	Skip forwards	Skips to the next track
	Volume -	Decreases the volume
	Opt in	No function
	Bluetooth	Turns Bluetooth mode on
	Wi-Fi	Turns Wi-Fi mode on
	Bass +	Increases the bass
	Treble +	Increases the treble
	Flat	Restores the bass and treble to zero
	Bass -	Decreases the bass
	Treble -	Decreases the treble
	d.bass	No function
	Number buttons	Selects the preset (1 to 6 only)

7. Troubleshooting

This troubleshooting guide contains solutions to problems which can be carried out by an ordinary person. The device does not contain user-serviceable parts.

Unauthorized modifications to the device will render the warranty void. Such modifications may result in injuries and material damage.

Refer servicing to instructed or skilled persons. Contact your Highlite International dealer in case the solution is not described in the table.

Problem	Probable cause(s)	Solution
The device does not function	No power to the device	<ul style="list-style-type: none"> Make sure that the power is switched on and the cables are plugged in Make sure that the device is not in standby mode
	Internal fuse is blown	<ul style="list-style-type: none"> Contact your Highlite International dealer
No sound	The volume is set to minimum	<ul style="list-style-type: none"> Increase the volume
The device cannot connect to Wi-Fi	Wi-Fi antenna is not connected	<ul style="list-style-type: none"> Make sure that the supplied Wi-Fi antenna is installed and in a vertical position
	Wi-Fi network is offline	<ul style="list-style-type: none"> Make sure that the Wi-Fi network is online Make sure that a DHCP server is available Make sure that the static IP address is configured Make sure that the firewall does not block the output ports
	The router limits access to MAC addresses	<ul style="list-style-type: none"> Make sure that the MAC address (Wi-Fi MAC or LAN MAC) is added to the allowlist of your router (AP)
	Wi-Fi signal is too weak	<ul style="list-style-type: none"> Move the device closer to the router
	Unsupported encryption method	<ul style="list-style-type: none"> Make sure that the encryption method is set to WEP, WPA or WPA2
	Incorrect Wi-Fi password	<ul style="list-style-type: none"> Enter the correct Wi-Fi password
The device cannot connect to Bluetooth	Bluetooth antenna is not connected	<ul style="list-style-type: none"> Make sure that the supplied Bluetooth antenna is installed and in a vertical position
The device does not respond to the remote control	The remote control is outside of the range of the infrared sensor	<ul style="list-style-type: none"> Make sure that there is a clear line of sight between the remote control and the IR sensor
	The batteries in the remote control are depleted	<ul style="list-style-type: none"> Change the batteries in the remote control

8. Maintenance

8.1. Safety Instructions for Maintenance



DANGER
Electric shock caused by dangerous voltage inside

Disconnect power supply before servicing or cleaning.

8.2. Preventive Maintenance



Attention
Before use, examine the device visually for any defects.

Make sure that:

- The housing is not damaged.
- The power cable is not damaged and does not show any material fatigue.

8.2.1. Basic Cleaning Instructions

To clean the device, follow the steps below:

- 01) Disconnect the device from the electrical power supply.
- 02) Allow the device to cool down for at least 5 minutes.
- 03) Clean the device with a soft, lint-free cloth.



Attention

- Do not immerse the device in liquid.
- Do not use alcohol or solvents.

8.3. Corrective Maintenance

The device does not contain user-serviceable parts. Do not open the device and do not modify the device.

Refer repairs and servicing to instructed or skilled persons. Contact your Highlite International dealer for more information.

9. Deinstallation, Transportation and Storage

- Use the original packaging to transport the device, if possible.
- Clean the device before storing.
- Store the device in the original packaging, if possible.

10. Disposal

Correct disposal of this product



Waste Electrical and Electronic Equipment

This symbol on the product, its packaging or documents indicates that the product shall not be treated as household waste. Dispose of this product by handing it to the respective collection point for recycling of electrical and electronic equipment. This is to avoid environmental damage or personal injury due to uncontrolled waste disposal. For more detailed information about recycling of this product contact the local authorities or the authorized dealer.

11. Approval



Hereby, Highlite International declares that the device SPA-100 Streaming Pre-Amplifier, product code D1242, is in compliance with Directive 2014/53/EU (RED – Radio Equipment Directive).

The full text of the EU declaration of conformity is available on the respective product page on the website of Highlite International (www.highlite.com).

DAP